

## Installation Instructions for the SS39ET/SS49E/SS59ET Series Linear Hall-Effect Sensor ICs

ISSUE 2  
50000353

### GENERAL INFORMATION

#### CAUTION

##### ELECTROSTATIC DISCHARGE DAMAGE

This component is sensitive to electrostatic discharge (ESD). Take normal ESD precautions in handling this product to prevent ESD-induced damage and/or degradation.

**Failure to comply with these instructions may result in product damage.**



**Table 1. Absolute Maximum Ratings**

Supply voltage ( $V_s$ )	-0.5 Vdc to 8.0 Vdc
Output current	10 mA
Storage temperature	-55 °C to 165 °C [-67 °F to 329 °F]

#### NOTICE

Absolute maximum ratings are the extreme limits that the device will withstand without damage to the device. However, the electrical and mechanical characteristics are not guaranteed as the maximum limits (above recommended operating conditions) are approached, nor will the device necessarily operate at absolute maximum ratings.

**Figure 1. Current Sourcing Output Block Diagram**

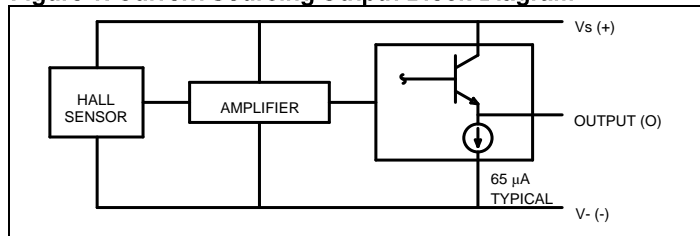

**Figure 2. Transfer Characteristics ( $V_s = 5.0$  Vdc)**

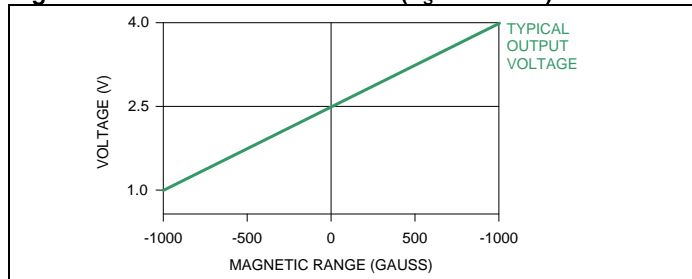

### SOLDERING/ASSEMBLY

#### CAUTION

##### SOLDERING INSTRUCTIONS

- Ensure leads are adequately supported during any forming/shearing operation so that they are not stressed inside the plastic case.
- Limit exposure to high temperatures.

**Failure to comply with these instructions may result in product damage.**

**Through-hole leads:** Wave solder at 250 °C to 260 °C [482 °F to 500 °F] for 3 s max.

**Surface-mount:** Use an infrared reflow process with temperatures of 245 °C [473 °F] peak for 10 s max.

#### CLEANING

Use agitated rinse. **Do not use pressure wash.** High-pressure stream could force contaminants into package.

**Figure 3. Null Shift versus Temperature**

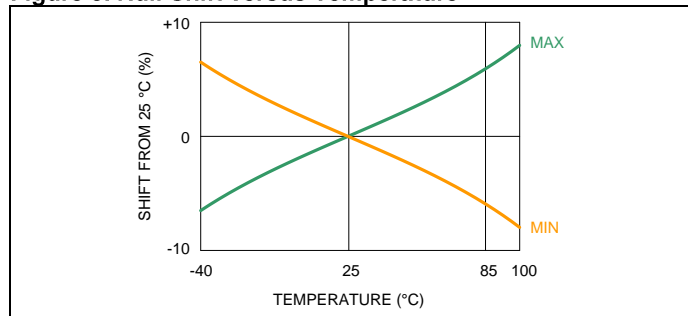

**Figure 4. Sensitivity Shift versus Temperature**

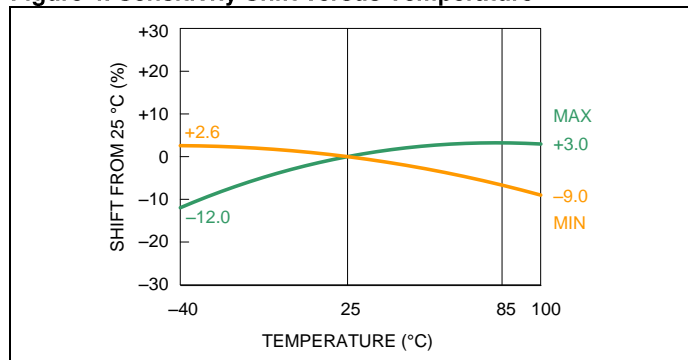

**Figure 5. Typical Frequency Response**

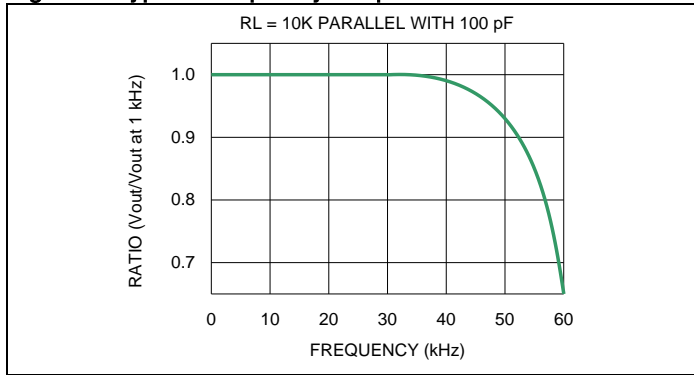

**Figure 6. Supply Current versus Temperature**

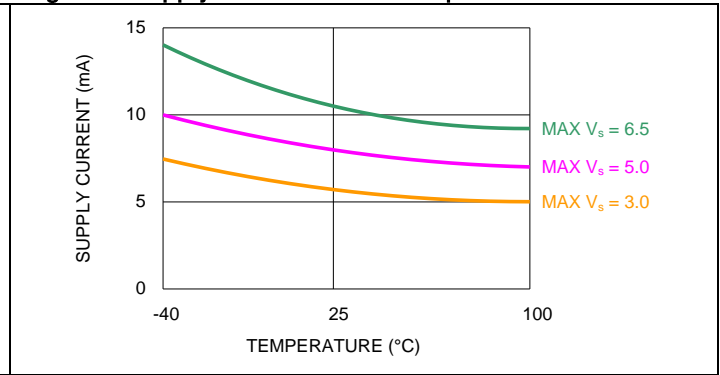

**Figure 7. Sensitivity per Volt versus  $V_s$**

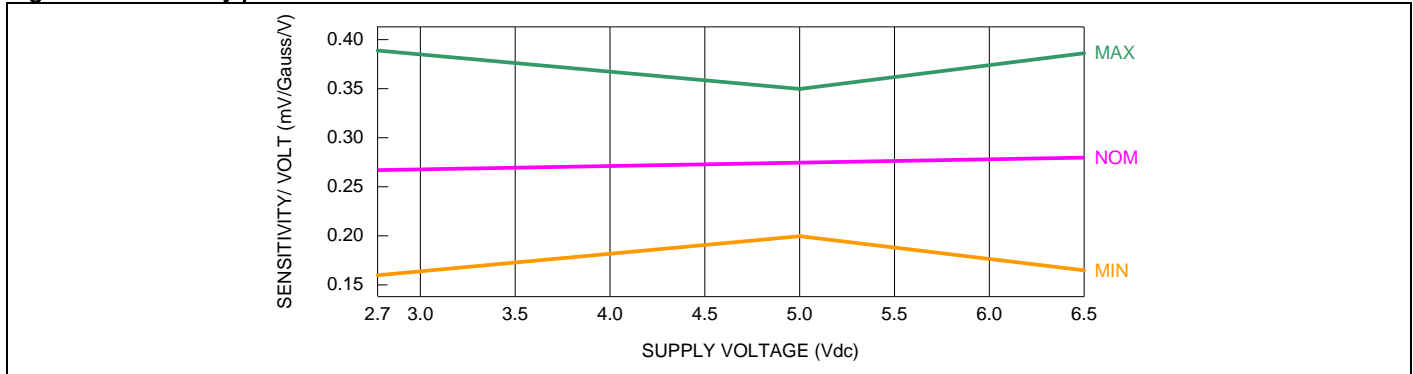

**Table 2. Operating Characteristics ( $V_s = 5.0$  V,  $T_A = -40$  °C to 85 °C [-40 °F to 185 °F], except where noted)**

Characteristic	Condition	Min.	Typ.	Max.	Unit
Output type	—	linear, sourcing			—
Magnetics type	—	analog			—
Supply voltage	—	2.7	—	6.5	Vdc
Supply current	25 °C [77 °F]	—	6	10	mA
Output voltage	—	1.0	1.4	1.75	mV/Gauss
Output current	$V_s > 3.0$ V	1.0	1.5	—	mA
Null	0 Gauss, 25 °C	2.25	2.50	2.75	Vdc
Output voltage span	—	1.05 to ( $V_s - 1.05$ )	0.95 to ( $V_s - 0.95$ )	—	Vdc
Magnetic range	—	±650	±1000	—	Gauss
Sensitivity	25 °C	1.0	1.4	1.75	mV/Gauss
Operating temperature	—	-40 [-40]	—	100 [212]	°C [°F]
Temperature error					
Null drift	—	-0.10	—	0.10	%°C
Sensitivity drift	≥25 °C	-0.15	—	0.05	
	<25 °C	-0.04	—	0.185	
Linearity	—	—	-0.7	—	% of span
Response time	—	—	3	—	μs



Figure 10. SS49E Mounting Dimensions (for reference only, mm/[in])

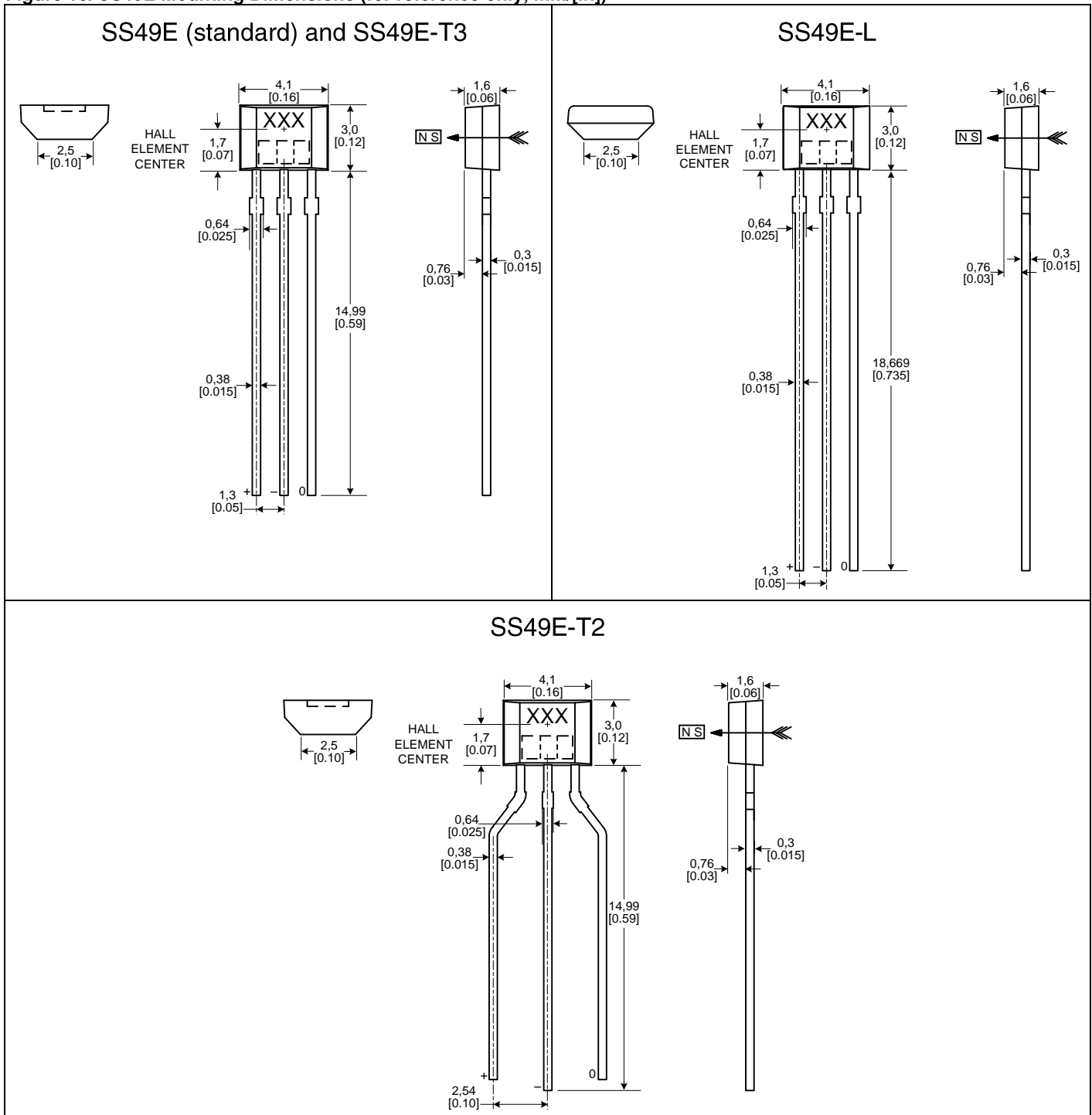

Figure 11. SS49E Tape Style T2

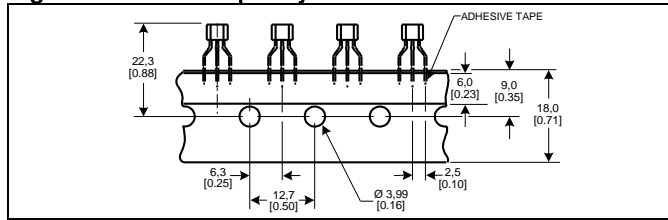

Figure 12. SS49E Tape Style T3

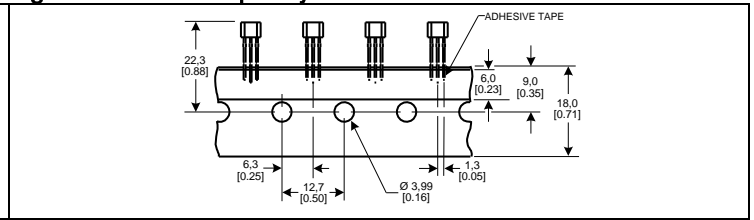

Figure 13. SS59ET Mounting Dimensions (for reference only, mm/[in])

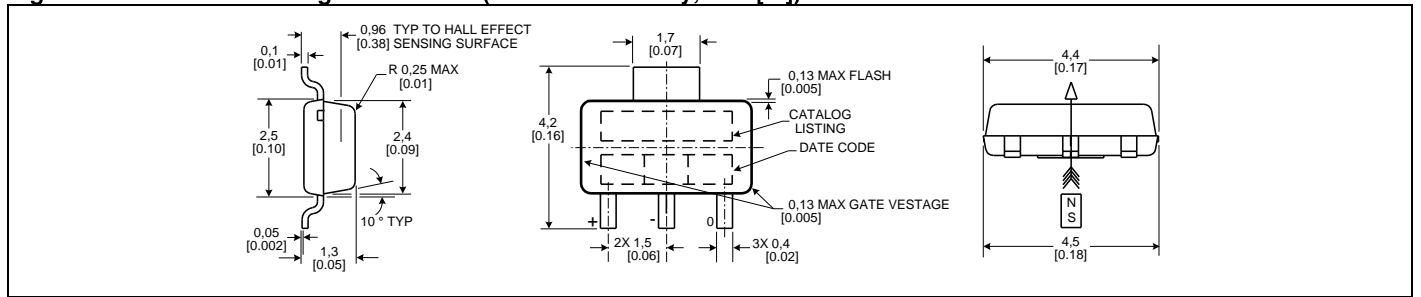
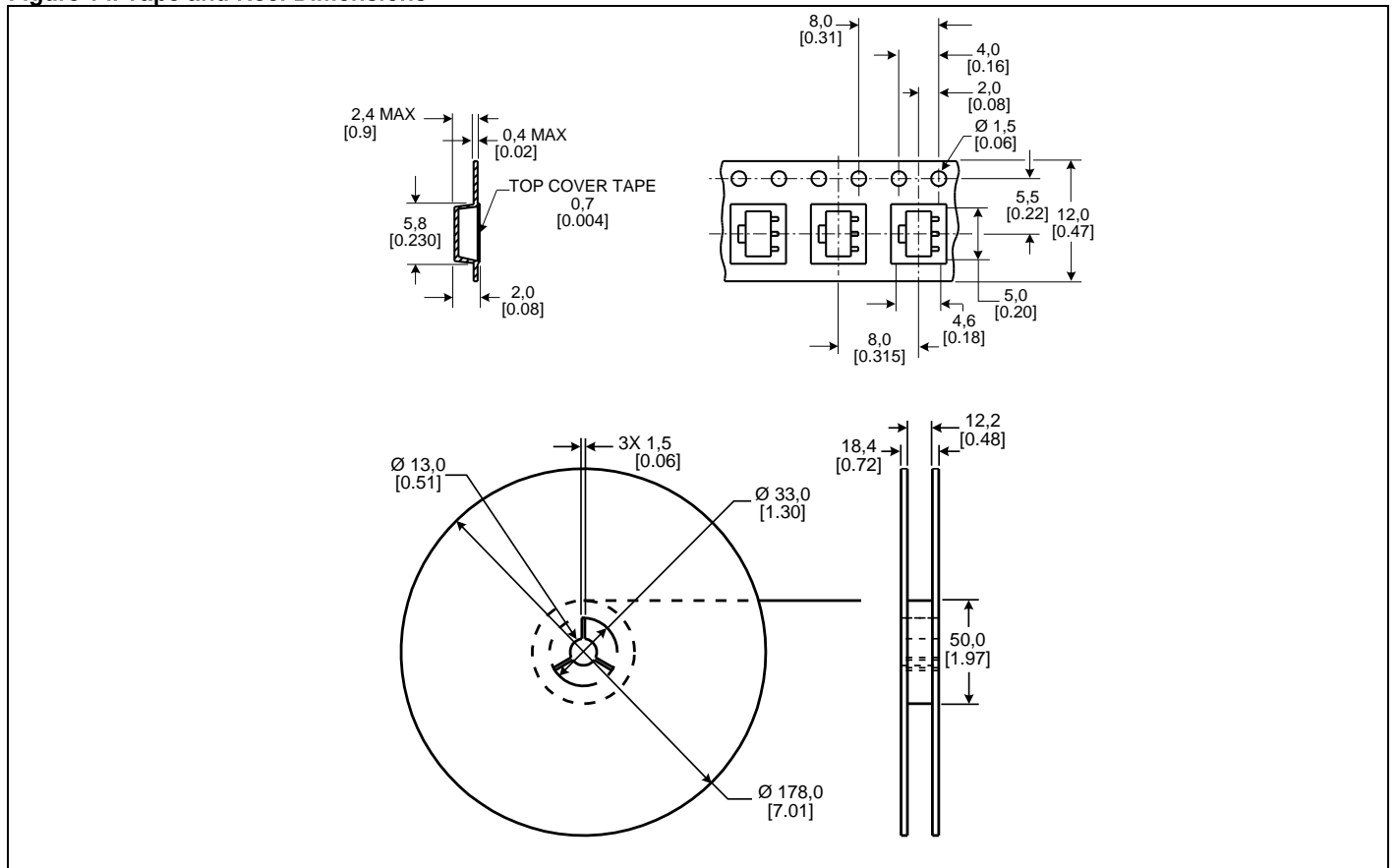

Figure 14. Tape and Reel Dimensions



## WARNING

### PERSONAL INJURY

DO NOT USE these products as safety or emergency stop devices or in any other application where failure of the product could result in personal injury.

**Failure to comply with these instructions could result in death or serious injury.**

### WARRANTY/REMEDY

Honeywell warrants goods of its manufacture as being free of defective materials and faulty workmanship. Honeywell's standard product warranty applies unless agreed to otherwise by Honeywell in writing; please refer to your order acknowledgement or consult your local sales office for specific warranty details. If warranted goods are returned to Honeywell during the period of coverage, Honeywell will repair or replace, at its option, without charge those items it finds defective. **The foregoing is buyer's sole remedy and is in lieu of all other warranties, expressed or implied, including those of merchantability and fitness for a particular purpose. In no event shall Honeywell be liable for consequential, special, or indirect damages.**

While we provide application assistance personally, through our literature and the Honeywell web site, it is up to the customer to determine the suitability of the product in the application.

Specifications may change without notice. The information we supply is believed to be accurate and reliable as of this printing. However, we assume no responsibility for its use.

### SALES AND SERVICE

Honeywell serves its customers through a worldwide network of sales offices, representatives and distributors. For application assistance, current specifications, pricing or name of the nearest Authorized Distributor, contact your local sales office or:

**E-mail:** [info.sc@honeywell.com](mailto:info.sc@honeywell.com)

**Internet:** [www.honeywell.com/sensing](http://www.honeywell.com/sensing)

### Phone and Fax:

Asia Pacific	+65 6355-2828
	+65 6445-3033 Fax
Europe	+44 (0) 1698 481481
	+44 (0) 1698 481676 Fax
Latin America	+1-305-805-8188
	+1-305-883-8257 Fax
USA/Canada	+1-800-537-6945
	+1-815-235-6847
	+1-815-235-6545 Fax