

SDP8105

Silicon Photodarlington

FEATURES

- T-1 plastic package
- 20° (nominal) acceptance angle
- Consistent optical properties
- Mechanically and spectrally matched to SEP8505 and SEP8705 infrared emitting diodes

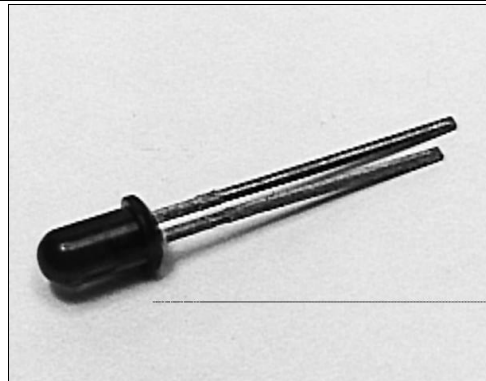

INFRA-55.TIF

DESCRIPTION

The SDP8105 is an NPN silicon photodarlington transfer molded in a T-1 black plastic package to minimize effect of visible ambient light. Transfer molding of this device assures superior optical centerline performance compared to other molding processes. Lead lengths are staggered to provide a simple method of polarity identification.

OUTLINE DIMENSIONS in inches (mm)

Tolerance 3 plc decimals ±0.005(0.12)
2 plc decimals ±0.020(0.51)

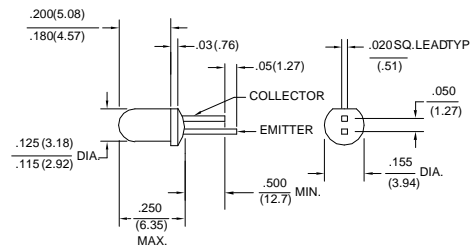

DIM_100.dwg

SDP8105

Silicon Photodarlington

ELECTRICAL CHARACTERISTICS (25°C unless otherwise noted)

PARAMETER	SYMBOL	MIN	TYP	MAX	UNITS	TEST CONDITIONS
Light Current SDP8105-001	I_L	0.5			mA	$V_{CE}=5\text{ V}$ $H=0.025\text{ mW/cm}^2$ (1)
Collector Dark Current	I_{CEO}		250		nA	$V_{CE}=10\text{ V}$, $H=0$
Collector-Emitter Breakdown Voltage	$V_{(BR)CEO}$	15			V	$I_C=100\text{ }\mu\text{A}$
Emitter-Collector Breakdown Voltage	$V_{(BR)ECO}$	5.0			V	$I_E=100\text{ }\mu\text{A}$
Collector-Emitter Saturation Voltage	$V_{CE(SAT)}$		1.1		V	$I_C=I_L/8$ $H=0.025\text{ mW/cm}^2$
Angular Response (2)	\emptyset		20		degr.	$I_F=\text{Constant}$
Rise And Fall Time	t_r, t_f		75		μs	$V_{CC}=5\text{ V}$, $I_L=1\text{ mA}$ $R_L=100\text{ }\Omega$

Notes

1. The radiation source is an IRED with a peak wavelength of 935 nm.
2. Angular response is defined as the total included angle between the half sensitivity points.

ABSOLUTE MAXIMUM RATINGS

(25°C Free-Air Temperature unless otherwise noted)

Collector-Emitter Voltage	15 V
Emitter-Collector Voltage	5 V
Power Dissipation	70 mW (1)
Operating Temperature Range	-40°C to 85°C
Storage Temperature Range	-40°C to 85°C
Soldering Temperature (5 sec)	240°C

Notes

1. Derate linearly from 25°C free-air temperature at the rate of 0.18 mW/°C.

SCHEMATIC

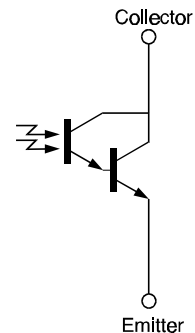

Honeywell reserves the right to make changes in order to improve design and supply the best products possible.

Honeywell

SDP8105

Silicon Photodarlington

SWITCHING TIME TEST CIRCUIT

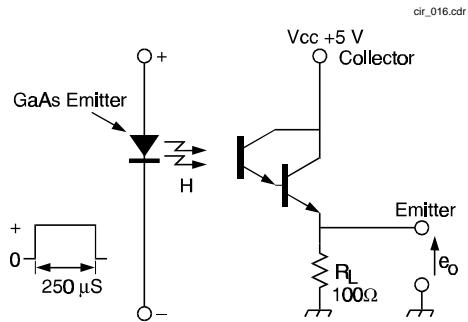

SWITCHING WAVEFORM

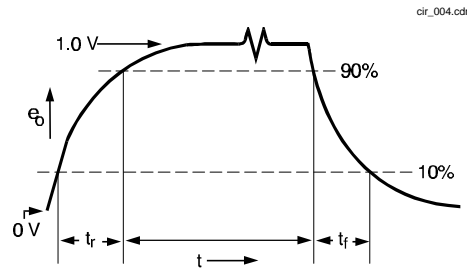

Fig. 1 Responsivity vs Angular Displacement

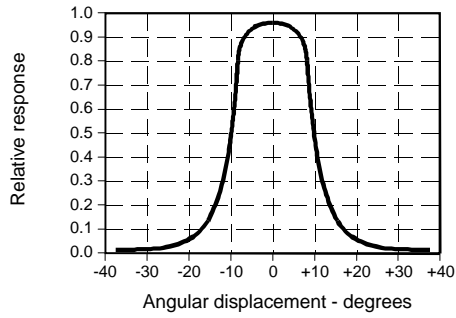

Fig. 2 Non-Saturated Switching Time vs Load Resistance

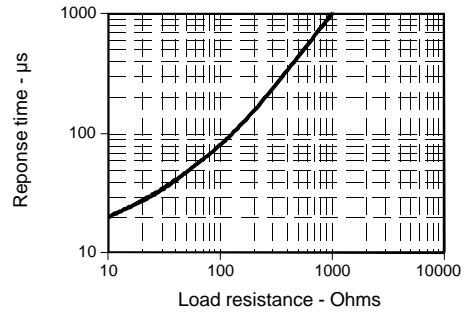
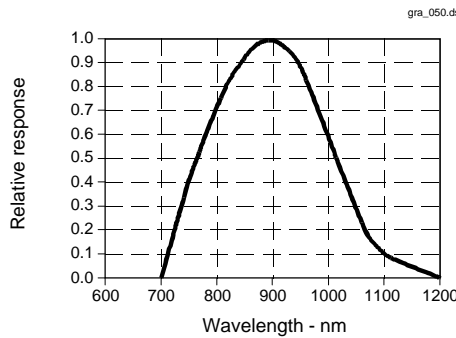

Fig. 3 Spectral Responsivity



All Performance Curves Show Typical Values

SDP8105
Silicon Photodarlington



Honeywell reserves the right to make changes in order to improve design and supply the best products possible.

Honeywell