

# *Magnetoresistance (MR) Transducers*

*And How to Use Them as Sensors*

1st. Edition, July 2004

**Perry A. Holman, Ph.D.**



# *Acknowledgments*

The author would like to thank Dr. James R. (Bob) Biard for many, many late night discussions on the subject. Also, Dr. Gilbert Morales for many discussions on the modeling methodology. The author would like to thank Jason Chilcote for help keeping the project on track, and having insights on several topics. Larry Rehn for allowing the time to complete the work.

This work was typeset with  $\text{\LaTeX} 2_{\epsilon}$ , utilizing the book format from Amy Hendrickson at TeXnology.

P. A. H.

# *1*

---

## *Introduction*

This chapter briefly discusses some background and historical information on magnetism and magnetoresistance. Additionally, the scope and general direction of the book is covered.

### **1.1 SCOPE AND DIRECTION OF THE BOOK**

The scope of this book is to discuss magnetic sensors, and specifically magnetoresistive (MR, non-GMR) sensors. The attempt is to give a introductory level understanding of the topics of magnets, magnetoresistive devices, electronics for sensors, noise, and applications. Then, several of the topics will have additional sections that go into greater detail on the topic at hand. The hope is that as different problems are solved, there becomes a greater understanding of the topic, and more difficult problems need to be tackled. Thus, information is provided to continue progress on the subject.

### **1.2 A BRIEF HISTORY OF MAGNETS**

Mankind has known magnets for thousands of years. One of the earliest known form of magnets is loadstone (or lodestone), an iron oxide ore, originally mined from a material called magnetite. The name magnet comes from a region of present-day Turkey, where much of the material was mined, Magnesia. Today, magnetic materials are important factors in technology, from memory to motors. Modern magnetic theory is based on the concept that small particles, each acting as a magnet, are grouped

in a material. One of the first records of the particle level of magnetization concept is from Emanuel Swedenborg in 1734 [1]. These individual particles may be as small as a single atom, or a larger system of many atoms. As anyone that ever investigated magnets is aware, magnets interact: north pole attracts south, so, the small particles interact. Around 1900, many experiments were conducted, and many theories proposed, to decipher the physics concerning magnetism. An interesting point concerned the loss of magnetization of magnetic materials above a certain temperature; today called the Curie temperature, from Pierre Curie of radioactivity fame. In 1907, Weiss suggested that the observed magnetic phenomenon could be explained by an interaction on the molecular level, called the molecular field, which was later shown to be similar to Swedenborg's suggestion. The molecular field is a good intuitive explanation of the situation, but is not completely correct; magnetism is a quantum mechanical effect. Noble prize winning physicist Richard Feynman states [2] all magnetism is based on relativistic quantum mechanics; electrons are Fermions, having a spin, and this spin creates a magnetic field. This level of understanding is beyond the scope of this work, but one should understand the entire complexity of the ideas behind magnetism. So, although magnetic materials have been known to society for a long time, much of the physics is not well understood, as one long time researcher stated [3] "... [it] is very complex and is not fully understood."

### **1.3 A BRIEF HISTORY OF MAGNETORESISTANCE**

In 1857, William Thomson (also known as Lord Kelvin, of Kelvin temperature scale fame) found that the resistance of iron changes when it is magnetized. This property, where the electrical resistance of a metal changes with an applied magnetic field is known as magnetoresistance. It has been found that many materials exhibit magnetoresistance. As of the 1960's, vacuum technology improved to the point that very pure, extremely small, films of materials were applied on a substrate, such as silicon or glass. Some of the earliest applications of thin film magnetic films were for memory devices, such as bubble memory and hard disk drives (HDD).

### **1.4 A BRIEF HISTORY OF PERMALLOY**

One of the early major applications of magnetic devices were transformers for use in electrical power distribution and telecommunications. In the realm of power distribution, power transfer efficiency is a critical factor. Some ferromagnetic materials lose energy to heat from the physical expansion and contraction of the material, caused by the magnetic field. This phenomenon, when a material changes physical dimension by an applied magnetic field, is called magnetostriction. A nickel-iron alloy ( $Ni_{81}Fe_{19}$ ) was found to have essentially zero magnetostriction, and was widely adopted as a transformer core material. Permalloy is the common name for approximately 80-20 nickel-iron alloys, and the name appears to have been coined (or trademarked) by Westinghouse in approximately 1910. The vast majority of discus-

sion within this book concerns thin film Permalloy; thickness of 1 nanometer to 1 micron, and widths of submicron to tens of microns.

## 1.5 HARD AND SOFT MAGNETIC MATERIALS

While reading about various magnetic materials and devices, one will come across the concept of hard and soft magnetic materials. Usually these terms are poorly defined, but in general the magnetization of a soft magnetic materials is easily modified by an external magnetic field. Soft materials may even be affected by the internal field from the device. Soft magnetic materials typically have a relative permeability,  $\mu_r$ , of greater than one (maybe 10 to several thousands). Hard magnetic materials are typically characterized by essentially being immune to the effects of external, or internal, magnetic field. The relative permeability of hard magnetic materials are near unity ( $\mu_r \approx 1$ ). Permanent magnetics are typically hard magnetic devices. Permalloy is typically considered a soft magnetic material.

## 1.6 COMPARE TO HALL

In this section we will compare MR to Hall. The Hall effect is a property exhibited by all conductors, and is well covered by Popovic [4]. In the Hall effect, a voltage is produced that is the cross product of the current and applied magnetic field (Lorentz force). Thus, Hall devices give direction of the applied magnetic field: a south pole gives one polarity of signal, and a north pole gives the opposite polarity. Semiconductor Hall devices are utilized as magnetic sensors, and respond to the field which is perpendicular to the plane of the device. Hall voltages are typically very small, for example, silicon Hall sensors have signals on the order of a few microvolts per Gauss. Permalloy thin films respond to the field in the plane of the film. Furthermore, Permalloy gives the same signal with either polarity. Hall devices are linear over a wide range of several thousand Oersteds, whereas Permalloy response is highly non-linear, and saturates at a low field value, perhaps 50 Oersteds. Hall shows essentially zero hysteresis, and Permalloy is anisotropic (defined in the glossary), with some directions exhibiting hysteresis, and other directions not.

## 1.7 CONVENTIONS

For the purposes of the discussions within this book, the north face of a magnet has the field pointing out (positive field), and south pole the opposite (negative field). The Earth's "North Pole" is actually a magnetic south pole.

## 1.8 UNITS

Electrical units are detailed in the appendix (A). Magnetic units are also detailed, but some comments are necessary. The rational (MKS) unit of magnetic field strength is amps/meter (A/m), and the unit of magnetic flux density is Tesla (SI). The CGS unit of magnetic field strength is Oersted, and the magnetic flux density unit is Gauss. Commonly, Gauss and Oersted are used in the United States of America, Tesla and A/m in Europe. 1 Tesla = 10,000 Gauss. In freespace, the numerical value of a Gauss and a Oersted is the same, but, when in the presence of a magnetic material (such as iron or Permalloy), Gauss and Oersted no longer track.

## REFERENCES

1. B.D. Cullity, *Introduction to Magnetic Materials*, Addison-Wesley, 1962.
2. R.P. Feynman, *The Feynman Lectures on Physics*, Addison-Wesley, 1964.
3. A. Aharoni, *Introduction to the Theory of Ferromagnetism, 2nd ed*, Oxford Science, 2000.
4. R.S. Popovic, *Hall Effect Devices.*, IOP Publishing, 1991.

# 2

---

## *Film Properties*

This chapter discusses the film properties of Permalloy, in terms of magnetic sensors. As a side note, the Permalloy films discussed herein are unharmed by external fields, at least up to several thousand Gauss (a few tenths of a Tesla).

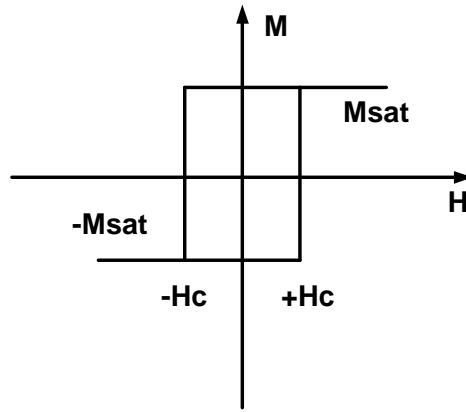
### **2.1 FILM DEPOSITION**

One begins with a substrate, or a base on which to create the magnetic films. The substrate is sometimes glass or ceramic, but if the Permalloy is to be integrated with an active circuit (amplifiers and the like), the substrate needs to be silicon wafers. The substrate must be smooth, since the film is thin. (Dimensions to be discussed later.) The Permalloy is deposited, by sputtering for example, on the substrate. Some more details of depositing the film is covered by Maissel and Glang [1]. For many magnetic films, the deposition is performed with a magnetic bias, to create a preferred magnetic direction, often referred to as the Easy Axis (EA). Alternatively, the preferred direction may be created after deposition by heating the film in the presence of an external field. The films described herein are processed with the Honeywell patented method [2].

### **2.2 DEPOSITED FILM PROPERTIES**

Once deposited, a reasonable question would be, “What are the properties of the material just deposited?” Commonly, two magnetic properties are measured,  $H_c$





**Fig. 2.1** Substrate Level Measurement of  $H_c$ .

and  $H_k$ . The values are measured in a B-H loop, detailed by Maissel and Glang. Numerical values of  $H_c$  and  $H_k$  are similar and typically about 5 Oersted. For “softer” materials, ie. more change with less externally applied field, the values of  $H_c$  and  $H_k$  are desired to be as low as possible.  $H_c$  may be thought of as the coercivity of the material, somewhat similar to the coercivity of a permanent magnet. Coercivity is defined as the externally applied field required to bring the resultant (of the externally applied, and intrinsic field from the material) to zero. The measurement of  $H_c$  is shown in Fig. 2.1. The saturation magnetization ( $M_{sat}$  or  $M_s$ ), is the strength of the magnetic moment of the film, and the value is around 10,000 Gauss (1 Tesla). Fig. 2.1 demonstrates that the magnetization direction ( $\vec{M}$ ) is parallel and anti-parallel to the Easy Axis, and exhibits hysteresis.  $H_k$  is the response of the magnetization of the film orthogonal to the Easy Axis, commonly referred to as the Hard Axis (HA), shown in Fig. 2.2.

### 2.3 RESISTANCE

This section will discuss the resistance properties of Permalloy. In general, for a rectangular block of uniform resistive material, the resistance (R) is found by:

$$R(\text{Ohms}) = \rho_v \frac{\text{Length}}{\text{Area}} = \rho_v \frac{\text{Length}}{\text{Width} \cdot \text{Thickness}} \quad (2.1)$$

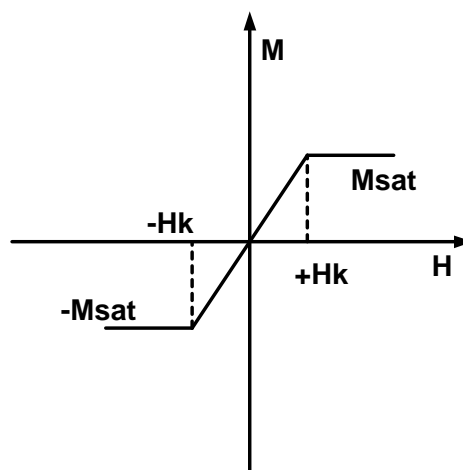
Where:

$\rho_v$  is the volume resistivity, Ohm · cm

*Length* is the length of the resistor

*Area* is the cross-sectional area of the resistor,  $\text{Area} = \text{Width} \cdot \text{Thickness}$

In some devices, such as semiconductors or thick film devices, the term of sheet



**Fig. 2.2** Substrate Level Measurement of  $H_k$ .

resistance, or  $\Omega/\square$  is often utilized. In other words:

$$R(\text{Ohms}) = \rho_{\square} \cdot \# \text{ of Squares} \quad (2.2)$$

Where:

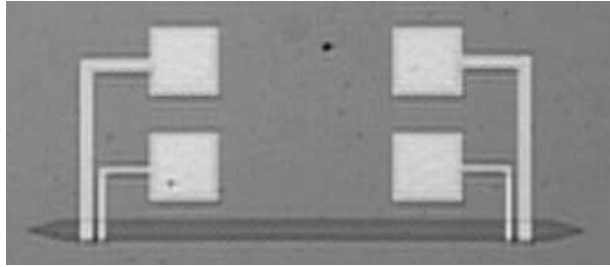
$\rho_{\square}$  is the sheet resistance (or sheet rho), Ohms/square ( $\Omega/\square$ )

The  $\rho_{\square}$  is often measured with a van der Pauw structure. Furthermore, the thickness of the film may be extracted by measuring the  $\rho_{\square}$ . For example, if you are expecting a  $\rho_{\square}$  of  $100 \Omega/\square$ , and the actual  $\rho_{\square}$  is  $50 \Omega/\square$ , then it is reasonable that the thickness is twice the expected value. The  $\rho_{\square}$  for the Permalloy of interest is around  $5 - 50 \Omega/\square$ . The thickness of the film is critical to device design.

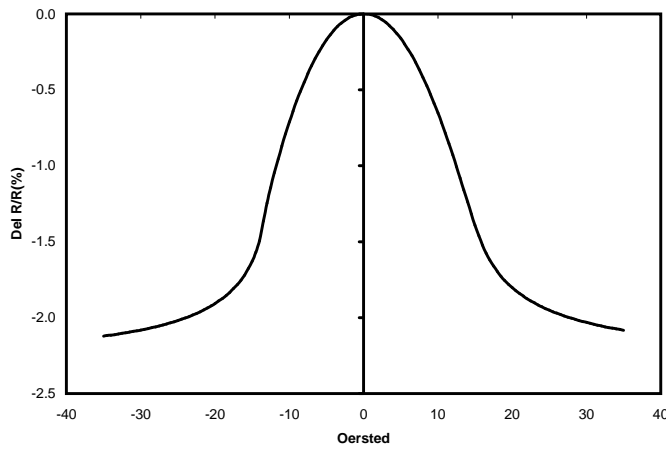
## 2.4 MEASUREMENTS

This section discusses measurements of resistors patterned parallel to the wafer level anisotropy, ie. the Easy Axis of the material is in line with the mechanical length of the resistor. A magnetic field applied to a Permalloy resistor often changes the resistance. One caveat, the applied field must be in the plane of the resistor. If a silicon wafer is on a table, the field has to be in the plane of the table, a field pointing out of the table does not change the resistance.

Since a more systematic evaluation is desired, the change in resistance per resistance ( $\Delta R/R$ ) is utilized, so that variations in baseline resistance values does not obscure the results. The resistors measured herein are very long, typically more than 20 squares, to keep the magnetization generally along the mechanical length of the resistor. Fig. 2.3 shows a picture of the type of resistors which were measured. The



**Fig. 2.3** Kelvin connected AMR Test Structure.



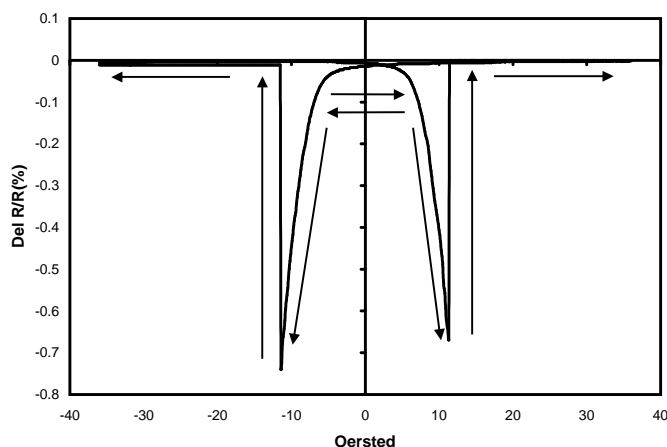
**Fig. 2.4** Simple Hard Axis (HA) Curve.

resistors use 4-point (Kelvin) contacts, to minimize the effect of contact resistance between the Permalloy and connecting metal.

### 2.4.1 Hard Axis

With a magnetic field applied perpendicularly to the mechanical length, in the Hard Axis (HA) direction, the response of the device is shown in Fig. 2.4 (250 Å thick Permalloy, 20 μm wide).

Notice the resistance decreases with applied field (the resistance is maximum at zero applied field). The maximum change is approximately 2.5%  $\Delta R/R$ , and is film thickness dependent, up to a bulk level of around 3.0%  $\Delta R/R$ . A thicker film typically has a higher  $\Delta R/R_{max}$ . The shape of the curve is somewhat like a normal (bell) curve. Additionally, sweeping the field up and down traces the curve, ie. there is no hysteresis in the HA response, similar to the  $H_k$  measurement.



**Fig. 2.5** Typical Measured “chirp” Resistance.

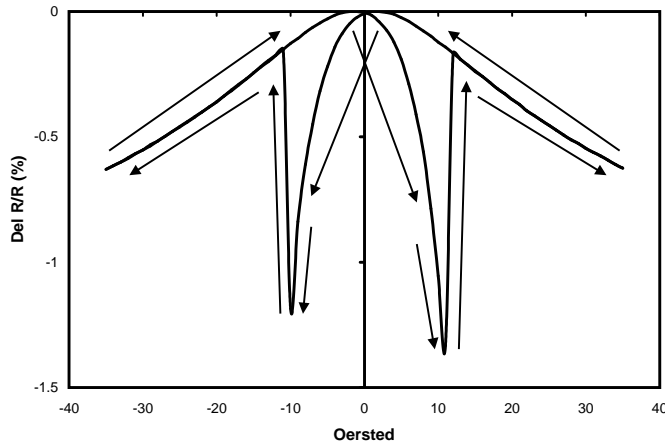
### 2.4.2 Easy Axis

With a field applied along the mechanical length of the resistor, in the Easy Axis (EA) direction, the technical literature states the resistance does not change with applied field. This is only partially correct. If the field stays in one direction, for example, an applied field swept along the resistor length 0 to 20 Oersted, (or 0 to  $-20$  Oersted) the resistance stays constant. But, if the applied field changes direction, for example sweep the field from  $-20$  Oersted to  $+20$  Oersted (and back to  $-20$  Oersted), the resistance exhibits a complicated change, Fig. 2.5 (250 Å thick Permalloy, 20  $\mu$ m wide).

The general shape of this curve is similar to an exponential, and then returns to the original resistance value. This curve will be referred to as a “chirp.” The field direction must change from positive to negative (or negative to positive) for the “chirp” to occur. Note: the externally applied magnetic field to cause the chirp is symmetrical, the field required to chirp in the upward going direction is essentially the same as the downward going direction. This value of externally applied field will be referred to as the “chirp-at” or “chirp@” value. Also note, the size ( $\Delta R/R$ ) of the upward and downward going “chirps” are approximately the same, referred to as the “chirp” size. The chirp-size in Fig. 2.5 is nearly 0.75%, compared to the full  $\Delta R/R$  of 2.5% in the Hard Axis direction, and occurs at low field value, thus it should not be ignored. Chirp-size is a function of resistor geometry, as discussed in the modeling chapter.

### 2.4.3 Off Axis

This section details the response of Permalloy with a field along neither the EA or HA, but at  $45^\circ$ . The response is a combination of the response in the two main axes, Fig. 2.6. There is a chirp action when the field changes direction, and there is a hard



**Fig. 2.6** Typical Measured “chirp” Resistance.

axis like response. Also, the size of the chirp in both directions is approximately the same, and is in fact larger than the “normal” response at 35 Oersted external field. Finally, the “chirp@” in the up and down directions are essentially identical.

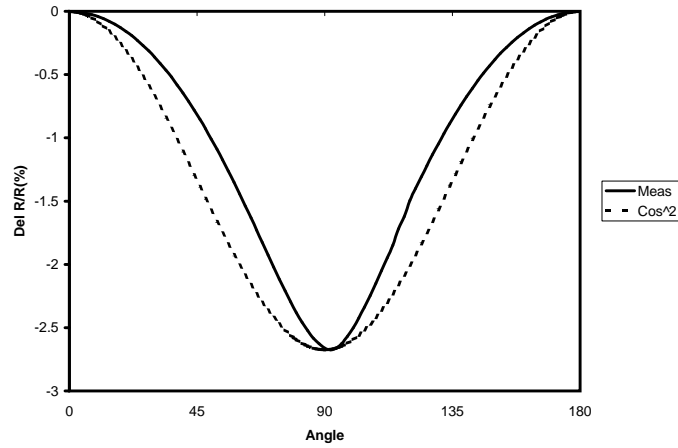
#### 2.4.4 Rotating Field

In the previous sections, the magnitude of the applied field changes, at a constant angle. Now, the discussion details a constant applied field value, but the field rotates in angle. The applied field value is assumed to be sufficient to saturate the material. Under these circumstances, the resistance changes with a  $\cos^2 \theta$  type relationship, where  $\theta$  is the angle between the direction of current flow, and the magnetization direction. This is a very good approximation, although Haji-Sheikh [3] showed the actual curve to be slightly more complex, but generally  $\cos^2 \theta$ . Fig. 2.7 shows the curve (385 Å thick Permalloy, 50 μm wide) of a constant field value, rotated over angle. Also, the figure shows a  $\cos^2 \theta$  curve for comparison. Note: the bottom of the curve is at  $90^\circ$ .

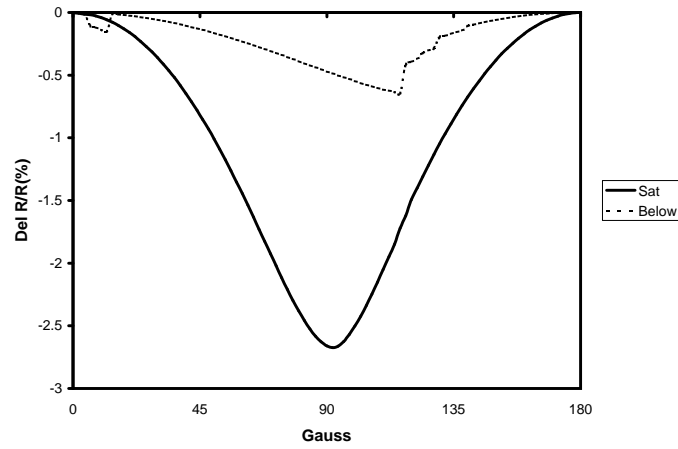
#### 2.4.5 Rotating Field Below Saturation

Now, if the applied field is not sufficiently large, the resistance does not follow the simple  $\cos^2 \theta$  relationship, Fig. 2.8.

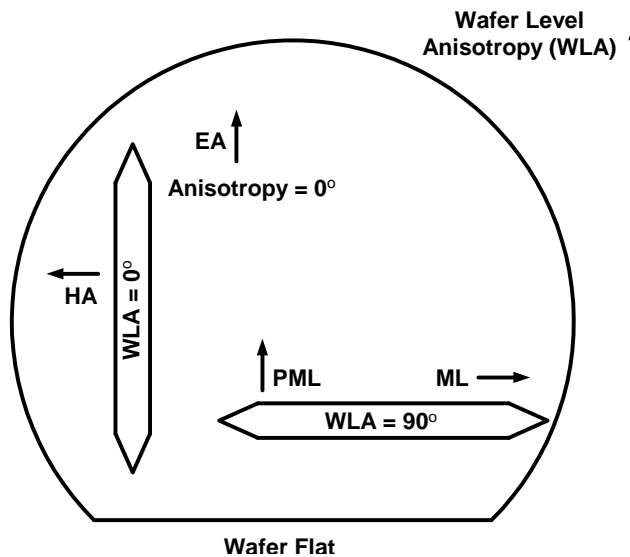
The solid curve is the saturated field value curve (35 Oersted), and the dashed line is below saturation field value (6 Oersted). Notice the resistance “lags” the magnetic field direction, then “chirps,” then leads. The resistance minimum is not at  $90^\circ$ , the minimum is at  $116^\circ$  in this case. The transition to saturation, such that there is no jump in the resistance curve (and the minimum resistance is at  $90^\circ$ ) is found experimentally to be  $|B_{chirp}| + 20$  Oersted.



**Fig. 2.7** Typical  $\Delta R/R$  with Rotating Field Above Saturation, with  $\cos^2$  for Comparison.



**Fig. 2.8** Typical  $\Delta R/R$  with Rotating Field Below Saturation.



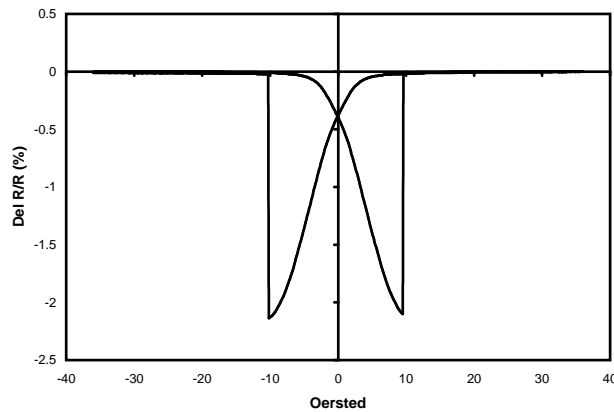
**Fig. 2.9** Wafer Level Anisotropy Defined.

## 2.5 ANISOTROPY EFFECTS

This section will discuss the impact of rotated anisotropy on the various Permalloy curves. At this point, it is necessary to explicitly define the terms that are utilized. So far, the discussion has been with the mechanical length (ML) of the resistor generally in line with the anisotropy, Easy Axis (EA). The preferred direction, created during deposition, is the wafer level anisotropy (WLA) direction, and the HA is perpendicular to this direction. But, the WLA may be in a generally different direction than the mechanical length of the resistor. If the mechanical length of the resistor is perpendicular to the WLA, then the WLA = 90°. With the EA and WLA generally in line, then WLA = 0°, Fig. 2.9. The direction perpendicular to the mechanical length is known as PML.

### 2.5.1 “Chirp” Anisotropy Effects

The largest effect of rotated anisotropy is dealing with the “chirp” phenomena. For “chirping” to occur, the field must be along the mechanical length (ML) of the resistor, perpendicular to the WLA. Fig. 2.10 shows a EA characteristic resistance curve of a resistor (250 Å thick Permalloy, 35 μm wide) that is patterned with a WLA = 90°. Note the size of the “chirp” is over 2%! Also, the shape of the curve is no longer exponential, but more logarithmic in nature, and is not minimum at zero applied field.



**Fig. 2.10** WLA=90°, ML Curve.

### 2.5.2 Hard Axis Anisotropy Effects

Fig. 2.11 shows a HA characteristic resistance curve for a resistor (250 Å thick Permalloy, 20 μm wide) that is patterned with a WLA of 90°. With WLA=90°, the HA is perpendicular to the mechanical length, and referred to as perpendicular to mechanical length (PML). One should note the curve is essentially the same as a normal (WLA = 0°) HA curve, with a slight jump, or “chirp,” in the up and down direction. The “chirp” is on the order of 1%  $\Delta R/R$ , which is approximately the same size as the “chirp-size” seen with a same-size resistor, with a WLA = 0°, and EA measurements. Also, the applied field value where the “chirp” occurs is at approximately 10 Oersted, and is in general agreement with the applied field required to “chirp” a normal device. In other words, the “chirp-size” and “chirp-at” values of the WLA=90° device is nearly the same as the nominal device (WLA=0°). Thus, the “chirp-size” and “chirp-at” values obtained from the nominal devices may be utilized to predict the “chirp” of the HA curve of a WLA=90° resistor.

### 2.5.3 Other Anisotropy Effects

In saturated mode, the anisotropy shows no impact on the response.

## 2.6 WIDTH EFFECTS

The width of a resistor has a significant impact on the magnetoresistance response of Permalloy. The terms often utilized are softness and hardness (or stiffness). A wider resistor is softer, meaning that the magnetization may be rotated more easily by an external field. Narrower resistors are harder (stiffer), and are less easily rotated by an external field. This can be explained by demagnetization. The edge of the resistor creates a demagnetization field, which opposes the rotation of the internal



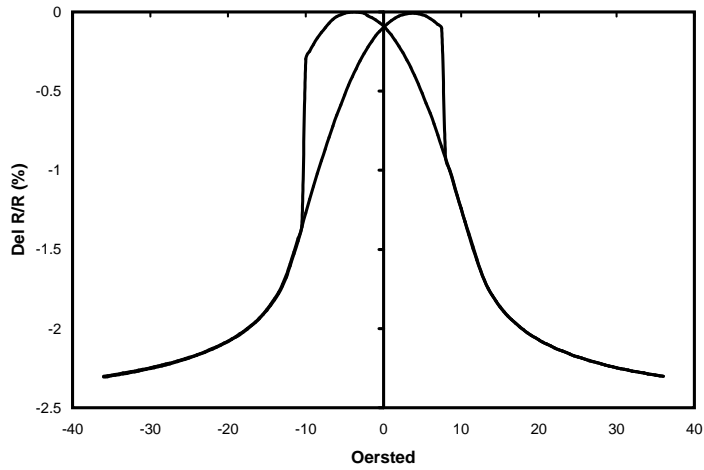


Fig. 2.11 WLA=90°, PML Curve.

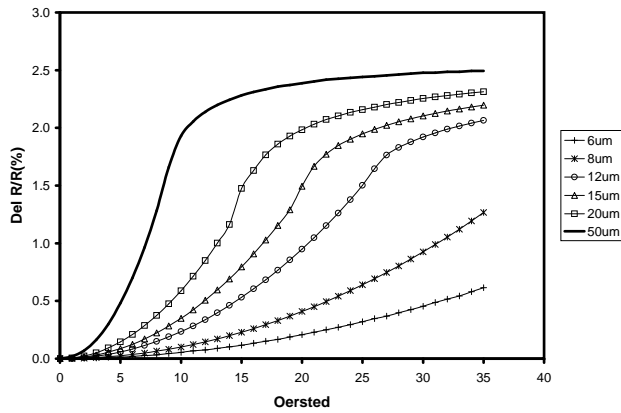


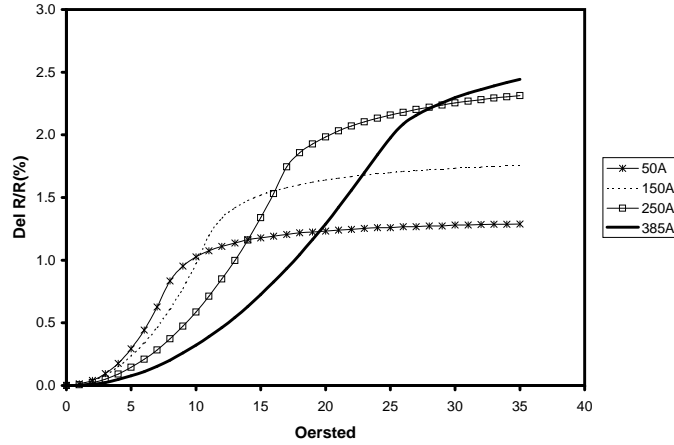
Fig. 2.12 Width Effect (250 Å Thick).

magnetization. A narrow resistor has the demagnetization close to the internal magnetization, making rotation more difficult, thus the resistor is magnetically stiffer. Fig. 2.12 shows the response of different resistor widths (250 Å thick) versus applied field.

The wider the resistor, the more resistance change with low field applied. And, less externally applied field is required to saturate the resistor. With the narrow resistor, the testing to 35 Oersted is not sufficient to saturate, although these resistors will eventually saturate.

**Table 2.1**  $\Delta R/R_{max}$  over Thickness.

Thickness (Å)	$\Delta R/R_{max}$ (%)
50	1.31
100	1.56
150	1.80
200	2.23
250	2.50
300	2.63
385	2.81

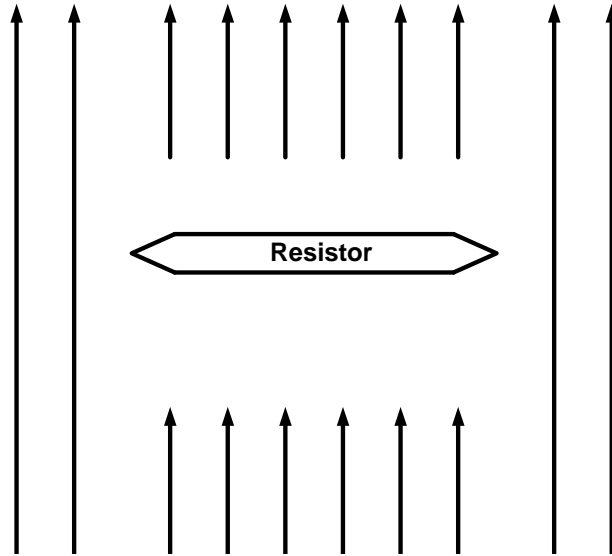


**Fig. 2.13** Thickness Effect (20 $\mu$ m Wide).

## 2.7 THICKNESS EFFECTS

Within the range of thicknesses that are discussed (50-400 Å), the thickness of the film has a major impact. Essentially, a thicker film has a larger maximum change in resistance,  $\Delta R/R_{max}$ , detailed in table 2.1. But, the thicker films require a larger externally applied field to reach saturation. Thinner films have a lower  $\Delta R/R_{max}$ , yet achieve a reasonable  $\Delta R/R$  (say, 1%) with less applied field, Fig. 2.13. Additionally, the thinner Permalloy has a higher  $\rho_{\square}$ , thus there are trade-offs that depend on the application.

For example, digital detection of a magnet probably requires a thinner film, to reach farther distances. A rotating large field, such as angle position sensor might utilize a thicker film. Eijkel [4] attempts to optimize this trade-off.



**Fig. 2.14** Uniform External Magnetic Field.

## 2.8 ADJACENCY EFFECTS

The discussion has covered the effect of resistor width and film thickness on an isolated (single) resistor. Now, this section will discuss the effect of multiple resistors in close physical proximity, the adjacency effect. First, remember the relationship between field value and flux density:

$$\vec{\mathbf{B}} = \mu \vec{\mathbf{H}} \quad (2.3)$$

Where  $\mu = \mu_r \mu_o$ , so  $|\vec{\mathbf{B}}|/|\vec{\mathbf{H}}|$  is the permeability. From the B-H curves mentioned earlier (Figs. 2.2 and 2.1), the relative permeability of Permalloy is not unity. Thus, a resistor of Permalloy will modify the magnetic field around the device. So, a group of resistors will also modify the external field, focusing the field. In fact, assuming an infinite permeability, the magnetic field is exactly perpendicular to the surface of the resistor. With finite permeability, the angle is the inverse tangent (arctan) of the ratio of the relative permeabilities:

$$\theta = \tan^{-1} \left( \frac{\mu_{r1}}{\mu_{r2}} \right) \quad (2.4)$$

If  $\mu_{r2} = 1$  (free space), and  $\mu_{r1} = 100$ ,  $\theta$  is  $89.4^\circ$ . Thus, perpendicular is a reasonable assumption, since the  $\mu_r$  of Permalloy is on the order of thousands. If the material is non-magnetic, a uniform external magnetic field will not be modified by the material, Fig. 2.14. And, with a high relative permeability material, say more than 10, the material will modify the field, such as Fig. 2.15.

Effectively, the resistors will see a larger magnetic field than the bulk applied field. The net result is the more resistors, and the closer the resistors, the more sensitive

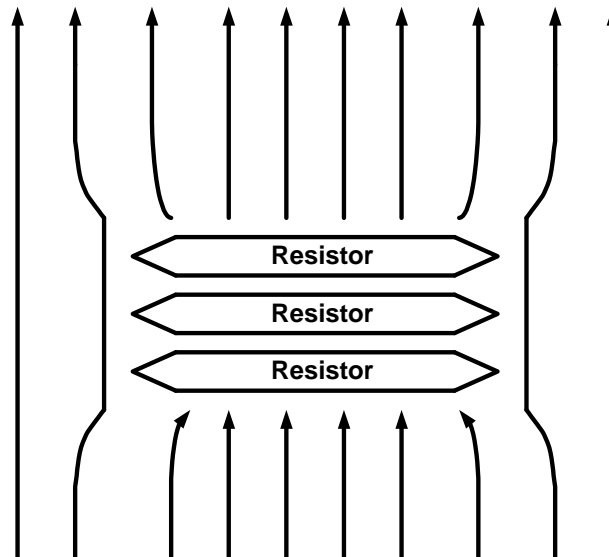


Fig. 2.15 Modified Uniform Magnetic Field.

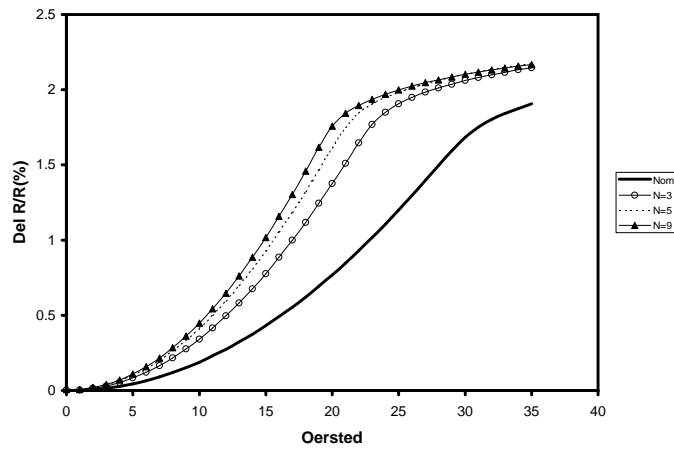


Fig. 2.16 Adjacency Effect.

the center resistors (Fig. 2.16). The figure shows the relationship between a single, isolated resistor, along with 3 resistors (N=3), 5 resistors (N=5), and 9 resistors, all with a spacing of  $2\mu\text{m}$  between resistors ( $385\text{ \AA}$  thick Permalloy).

Note: one outcome of this concept is that the inner resistor, and the outer resistor are in the same field, and thus have the same  $\Delta R/R$  response, which agrees with measurement, and disagrees with other published information [5].

**Table 2.2** TCR versus Thickness of Film.

Thickness (Å)	TCR (%/°C)
50	0.136
100	0.160
150	0.182
200	0.217
250	0.252
300	0.257
385	0.294
Bulk	~0.38

## 2.9 TEMPERATURE EFFECTS

There are two main effects on Permalloy from temperature. First, the baseline resistance, with zero applied magnetic field, has a temperature coefficient of resistance (TCR). Permalloy has predominately linear TCR of approximately +3000ppm/°C (+0.3%/°C), and is thickness dependent. In fact, some vendors offer a Permalloy resistor temperature sensor. Second,  $\Delta R/R$  is a function of temperature, which is dominated by the TCR. Imagine the resistance of Permalloy as a series combination of a baseline resistor ( $R_b$ ), and a magnetically sensitive resistor ( $R_m$ ). At a constant temperature, the change in resistance ( $\Delta R$ ) is due only to the magnetic change.

$$\Delta R = R_m \quad (2.5)$$

Then,  $\Delta R/R$  is:

$$\frac{\Delta R}{R} = \frac{R_m}{R_b} \quad (2.6)$$

The magnetically sensitive resistance ( $R_m$ ) is essentially temperature independent, but the baseline resistance ( $R_b$ ) has a TCR. So, with an increase of 100°C,  $R_m$  stays the same, and  $R_b$  increases 30%, and:

$$\frac{\Delta R}{R}(T) = \frac{R_m}{R_b(T)} \quad (2.7)$$

So, the  $\Delta R/R$  decreases 30%. The temperature coefficient of resistance (TCR) as a function of thickness is detailed in table 2.2.

## 2.10 DIMENSIONS

In the configuration presented, the thickness of the film is on the order of a few hundred Angstroms (Å, 1 Å =  $10^{-10}$  meter), the width is on the order of a few to tens of microns, and the length is approximately hundreds to thousands of microns.

## 2.11 VOLTAGE AND CURRENT EFFECTS ON RESISTANCE

The voltage coefficient of resistance (VCR) is the change in resistance of a resistor with an applied voltage. Typically, the current coefficient of resistance is not discussed as such. With Permalloy, there is no change in resistance with applied voltage or current, but, as with most topics, one must be careful. As detailed earlier, Permalloy has a strong temperature coefficient of resistance. Also, electrical power applied will tend to heat the resistor, thus care is required that the temperature of the resistor is not unintentionally increased during the measurement. One method to do this is to have a large heat-sink on the device, and keep the heat-sink at a specific temperature. (As a side note, a Hall effect transducer is generally affected by voltage, i.e. there is a VCR.)

## REFERENCES

1. L.I. Maissel and R. Glang, *Handbook of Thin Film Technology*, Mc-Graw Hill, 1970.
2. M. Haji-Sheikh, US Patent No. 5,667,879.
3. M.J. Haji-Sheikh, A. Koymen, G. Morales, and B. Altuncevahir, "Anisotropic Magnetoresistive Model for Thin Continuous Strips in High External Field," to be published.
4. K.J.M. Eijkel and J.H.J. Fluitman, "Optimization of the Response of Magnetoresistive Elements," 1990, IEEE Trans. Magn., 26, No 1, 311-321.
5. B.B. Pant, "Effect of interstrip gap on the sensitivity of high sensitivity magnetoresistive transducers," JAP, 79, 15 April 1996.

# 3

---

## *Modeling*

This chapter discusses modeling of the behavior of the resistive response of Permalloy to an externally applied magnetic field. First, a new, simple, linear, vector model is presented. This model is recommended for design of sensors. Then, the discussion covers the traditional model, Stoner-Wohlfarth (SW). Finally, some other models are detailed.

### 3.1 VECTOR MODEL

The proposed model is linear, simple, and vector, which utilizes anisotropy. This anisotropy is a constant value, found experimentally from the value of the “chirp-at” nominal device of the same geometry. The total field at the resistor is found as the vector sum of the applied field ( $\vec{\mathbf{B}}_a$ ) and the anisotropy field vector:

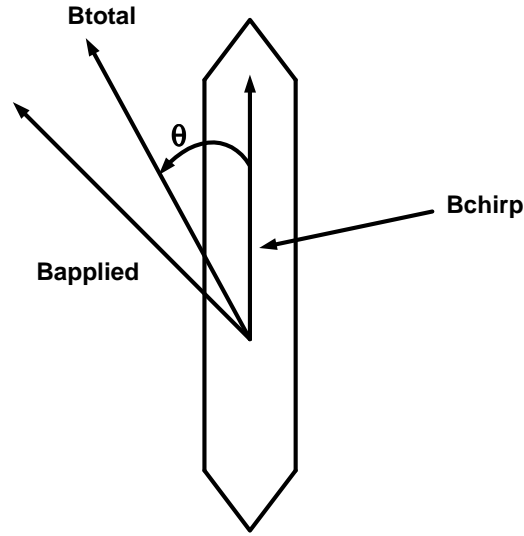
$$\vec{\mathbf{B}}_T = \vec{\mathbf{B}}_a + \vec{\mathbf{B}}_{chirp} \quad (3.1)$$

The vector may be represented as a magnitude and direction:

$$\vec{\mathbf{B}}_T = \mathbf{B}_T \angle \theta \quad (3.2)$$

The angle ( $\theta$ ) is the direction of the magnetic moment, relative to the current flow. Thus,  $\Delta R/R$  is found from this  $\theta$ , and  $\Delta R/R_{max}$ .

$$\Delta R/R = \Delta R/R_{max} \cdot \cos^2 \theta \quad (3.3)$$



**Fig. 3.1** Representation of Vector Model.

A visual representation is given in Fig. 3.1. For a simple example, assume the resistor is in the y-direction, and  $|\vec{\mathbf{B}}_{chirp}|$  is 10 Gauss. Now, apply a 10 Gauss field in the Hard Axis (x-direction). The total field is:

$$\vec{\mathbf{B}}_T = \vec{\mathbf{B}}_a + \vec{\mathbf{B}}_{chirp} = 10 \hat{x} + 10 \hat{y} = 14.1 \angle 45^\circ \quad (3.4)$$

Thus,  $\theta$  is  $45^\circ$ , and if  $\Delta R/R_{max}$  is 2.0%, then:

$$\Delta R/R = \Delta R/R_{max} \cdot \cos^2 \theta = 2.0\% \cdot \cos^2(45^\circ) = 1.0\% \quad (3.5)$$

So,  $\Delta R/R = 1.0\%$  in this example.

### 3.1.1 Four Quadrant

The four quadrant model comes into effect when  $\theta$ , from  $\vec{\mathbf{B}}_T$ , becomes  $90^\circ$  from the original direction, and then  $\vec{\mathbf{B}}_{chirp}$  flips to the opposite direction, Fig. 3.2.

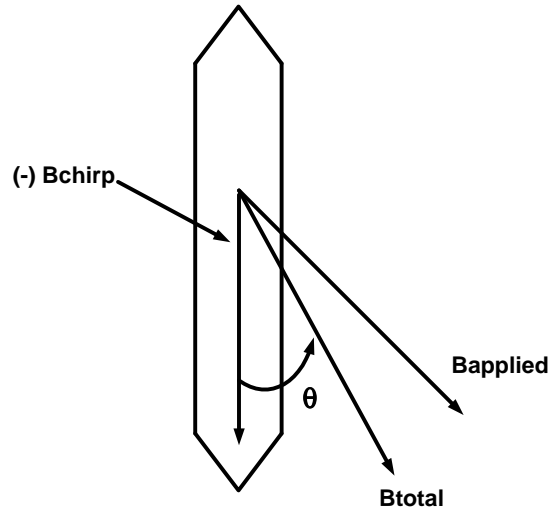
Equivalently, if the total applied field along the Easy Axis surpasses  $\vec{\mathbf{B}}_{chirp}$ , or conversely,  $\vec{\mathbf{B}}_T$  in the easy axis direction is zero, the  $\vec{\mathbf{B}}_{chirp}$  reversal occurs.

### 3.1.2 Off Axis

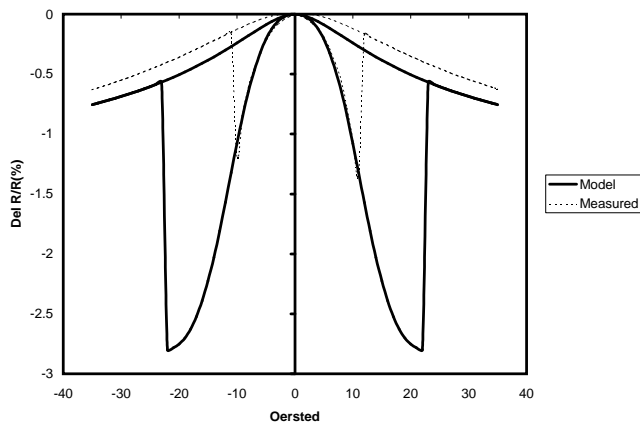
Using the simple model for off axis ( $45^\circ$ ) externally applied field, the result is shown in Fig. 3.3.

The general shape of the curve is reasonable, outside of the chirp area. So, if  $\theta$  is greater than  $90^\circ$ , the value of  $\vec{\mathbf{B}}_{chirp}$  changes direction, leading equation (3.1), to become (3.6):

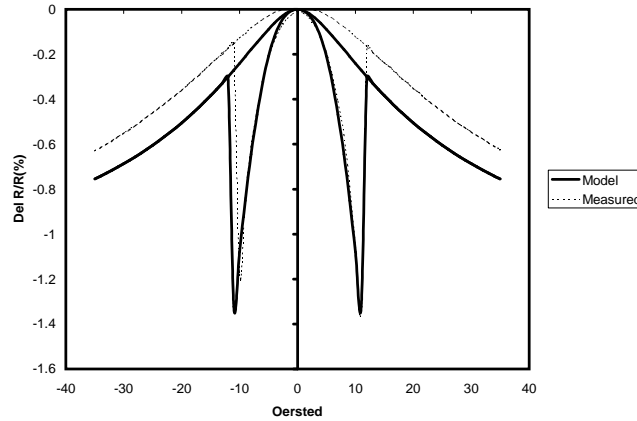




**Fig. 3.2** Vector Model in Flipped State.



**Fig. 3.3** Simple Model,  $45^\circ$ , Four Quadrant.



**Fig. 3.4** Modified Model, 45°, Four Quadrant.

$$\vec{B}_T = \vec{B}_a - \vec{B}_{chirp} \quad (3.6)$$

But, due to the high permeability of the material, the internal magnetization is different than the externally applied field. If the magnetization reverses at 45°, the model predicts Fig. 3.4. This modification agrees extremely well with the measured data.

### 3.1.3 $B_{chirp}$ and “Chirp-Size”

Since the value of  $\vec{B}_{chirp}$  utilized for the model is found experimentally, a graph of the values is in Fig. 3.5. Note, as the film is thicker, the “chirp@” value increases. Additionally, a narrower (stiffer) film has a larger  $\vec{B}_{chirp}$  value.

This reported data was measured in a uniform field, with five measurements over a  $\pm 2^\circ$  range, averaged. The “chirp-size” information was extracted from the same measurements, and is detailed in Fig. 3.6. The unusual data point (300 Å, 20  $\mu m$ ) is likely to be an anomaly, but has been reproduced several times. Perhaps there is a non-obvious minimization with this geometry.

### 3.1.4 Limitations of Vector Model

Some limitations of the vector model should be pointed out. First, as stated above, the off axis 45° applied field, needs to have a slight modification to match the measured data. Second, the effect of adjacent resistors is not easily modelled, except by modifying the externally applied field value. Third, rotated anisotropy is not well predicted by the vector model. Next, a field exactly along the mechanical length (Easy Axis, chirp measurements) is not modelled by the simple, single domain method. Modeling of the chirp requires a more complex, multi-domain model [1].

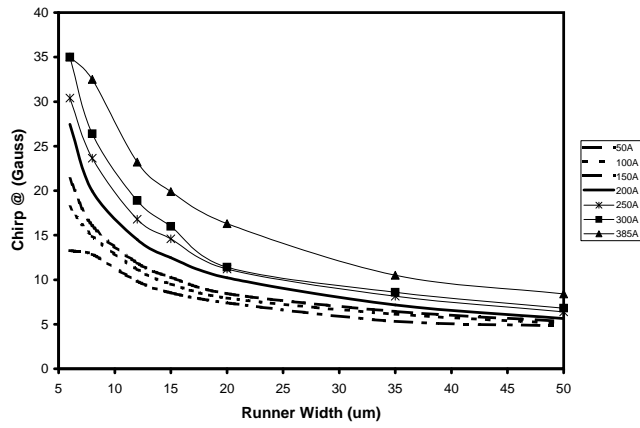


Fig. 3.5  $B_{chirp}$  versus the Resistor Width and Thickness.

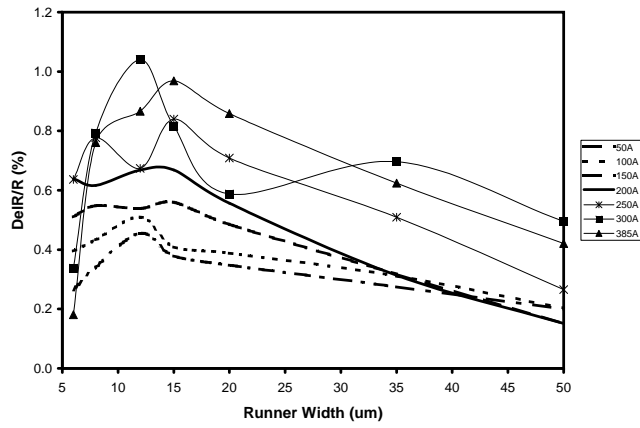


Fig. 3.6 "Chirp"  $\Delta R/R_{max}$  versus Resistor Width and Thickness.

### 3.2 STONER-WOHLFARTH MODEL

In 1947 Stoner and Wohlfarth (SW) published a single domain model for magnetization (reprint in 1991 [2]). Once the angle of rotation of the magnetization ( $\theta$ ) is known, there is a  $\cos^2 \theta$  relationship between the magnetization direction and the current flow direction, which is utilized to calculate  $\Delta R/R$ . It should be pointed out that the original SW paper mentions the following analysis is a first approximation for hexagonal cobalt. This model has shown to be useful over time and with different materials. The magnetic anisotropy energy due to the crystal orientation:

$$E_k = K \sin^2 \theta \quad (3.7)$$

Where  $K$  is the anisotropy constant. The energy from the externally applied magnetic field of magnitude  $H_a$  at the angle of  $\phi$  applied relative to the mechanical length of the resistor, Easy Axis.

$$E_H = -H_a M_s \cos(\phi - \theta) \quad (3.8)$$

Where  $M_s$  is the saturation magnetization, defined above. The energy component from the demagnetization field ( $H_d$ ) is given by:

$$E_d = -H_d M_s \sin \theta \quad (3.9)$$

Assuming the Easy Axis is in line with the mechanical length of the resistor, the total energy is ( $E_T$ ):

$$E_T = E_k + E_H + E_d \quad (3.10)$$

Now, to find the internally rotated angle  $\theta$ , take the derivative with respect to  $\theta$ , and set equal to zero. Then, use  $K = H_k M_s / 2$ , and divide through by  $M_s$  ( $E = E_T / M_s$ ) thus:

$$\frac{\partial E}{\partial \theta} = H_k \cos \theta \sin \theta - H_a \sin(\phi - \theta) - H_d \cos \theta \quad (3.11)$$

#### 3.2.1 Hard Axis SW Model

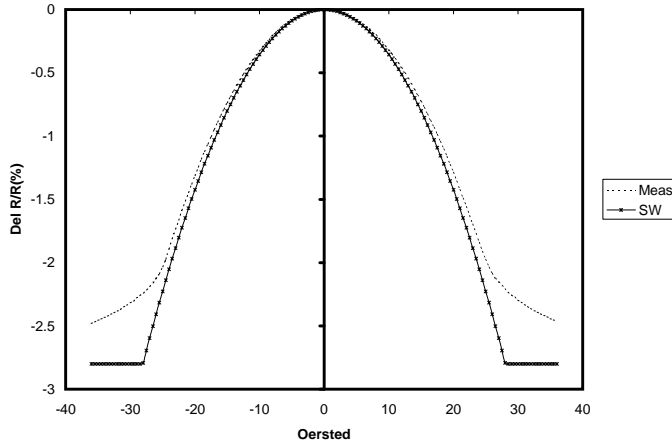
If  $\phi$  equals  $90^\circ$ , the applied field is in the Hard Axis direction, and the equation becomes:

$$\frac{\partial E}{\partial \theta} = H_k \cos \theta \sin \theta - H_a \cos \theta - H_d \cos \theta = 0 \quad (3.12)$$

Assuming  $\cos \theta$  is non-zero, divide through, giving:

$$\sin \theta = \frac{(H_a + H_d)}{H_k} \quad (3.13)$$

Typically,  $H_d$  is a fraction of  $H_a$ , and is negative. To solve equation (3.13) use:



**Fig. 3.7** SW Model vs Measured. ( $385\text{\AA}/20\mu\text{m}$ )

$$H = (H_a + H_d) = \eta H_a \quad (3.14)$$

And,

$$\eta = 3.344 \cdot \text{width}/\text{thickness} \quad (3.15)$$

Thickness is in Angstroms, and width is in microns. Thus, a  $385\text{\AA}$  thick and  $12\mu\text{m}$  wide resistor gives  $\eta = 0.104$  (unitless). And,  $H_k$  is a basic material property. The total SW model is given by equation (3.16):

$$\theta = \sin^{-1} \left( \frac{3.344 \cdot H_a \cdot \text{width}/\text{thickness}}{H_k} \right) \quad (3.16)$$

And,

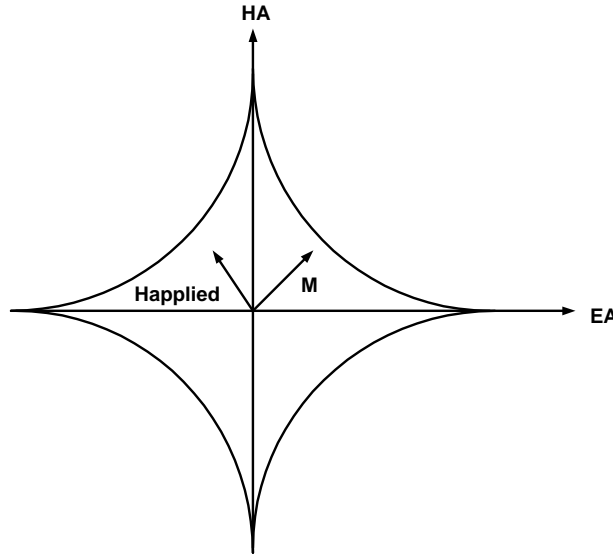
$$\Delta R/R = \Delta R/R_{max} \cdot \cos^2 \theta \quad (3.17)$$

The value of  $H_k$  is on the order of 5 Oersted, so if the applied field value is above approximately 10 Oersted, (3.13) becomes invalid. Usually, the value of (3.13) is limited, such that  $\theta$  is  $90^\circ$  if  $(H_a + H_d)/H_k$  is greater than 1. Fig. 3.7 plots the response of a  $385\text{\AA}/20\mu\text{m}$  resistor, measured data versus SW model ( $\eta = 0.1783$ ).

The SW model agrees well with measured data, within approximately  $\pm 23$  Oersted. Outside of this region, SW predicts saturation, although the resistor has not saturated.

### 3.2.2 Off Axis SW Model

With the applied field at some angle other than  $90^\circ$ , equation (3.11) becomes more complex than equation (3.13):



**Fig. 3.8** SW Asteroid with applied field less than flip.

$$\sin \theta - \frac{H_a}{H_k} \sin \phi - \frac{H_d}{H_k} = -\frac{H_a}{H_k} \cos \phi \tan \theta \quad (3.18)$$

Which is not known to have a closed form solution. Some researchers, such as Pant [3], describe a non-single domain method to solve equation (3.18). The vector model, detailed above, models off axis affects in a straightforward manner.

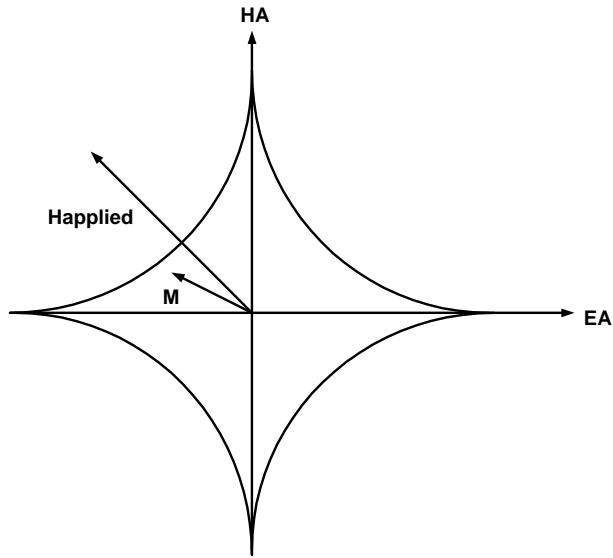
### 3.2.3 Four Quadrant SW Model

The Stoner-Wohlfarth calculations are energy (scalar) only, and hysteresis is not typically included. Using the information above, the question becomes how the magnetization rotates in four quadrants. Essentially, if a small field is applied in a different quadrant (Fig. 3.8), the magnetization rotates to satisfy equation (3.10). But, after removal of the field, the magnetization returns to the original position, (EA).

If a sufficiently large field is applied in a different quadrant, such that the vector of the applied field  $H_a$  is outside of the critical contour, defined below, the magnetization rotates such as shown in Fig. 3.9.

Then, when the field is removed, the internal magnetization direction does not return to the initial state, but the final state is in the anti-parallel direction (-EA). The critical contour is known as the Stoner-Wohlfarth asteroide, and is given by [4]:

$$(h_{\parallel})^{\frac{2}{3}} + (h_{\perp})^{\frac{2}{3}} = 1 \quad (3.19)$$



**Fig. 3.9** SW Asteroid with applied field greater than flip.

**Table 3.1** Utilized  $B_{chirp}$  Values.

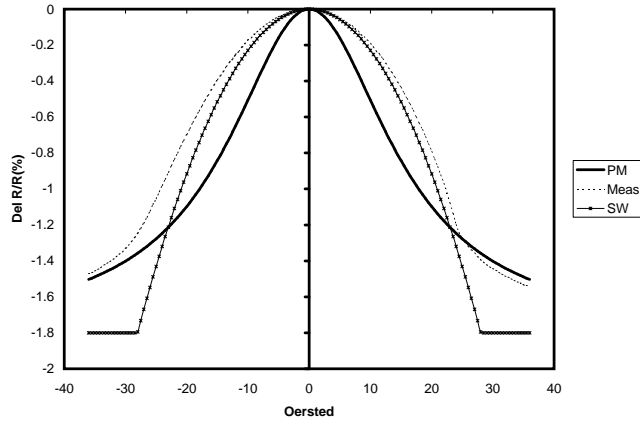
Thickness ( $\text{\AA}$ )/Width ( $\mu m$ )	$B_{chirp}$ (Gauss)
150/8	16.0
250/35	8.15
385/20	16.3

Where  $h_{\parallel}$  is the field applied parallel to the EA, divided by  $H_k$ , and  $h_{\perp}$  is the field applied in the HA direction, divided by  $H_k$ . Since the SW model has limitations on field value and four quadrant response, the VM was created.

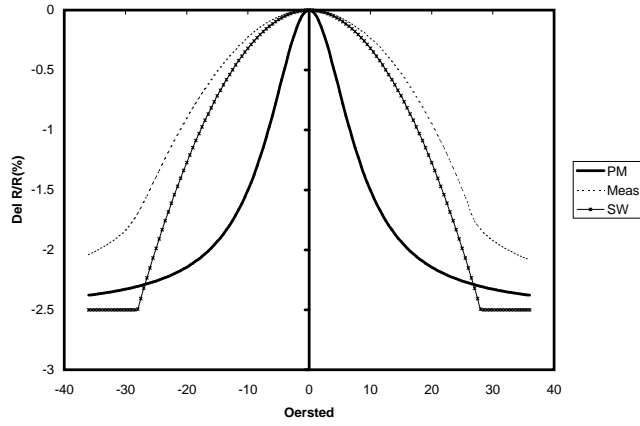
### 3.3 VALIDATION

The next several graphs are the results of utilizing the vector model (VM), with comparison to measured data and the Stoner-Wohlfarth (SW) model. The data is from  $150\text{\AA}/8\mu m$  (Fig. 3.10),  $250\text{\AA}/35\mu m$  (Fig. 3.11), and  $385\text{\AA}/20\mu m$  (Fig. 3.12) resistors.

The values of  $\vec{B}_{chirp}$  used for the validation are summarized in table 3.1. And, the  $\Delta R/R_{max}$  values are taken from table 2.1.

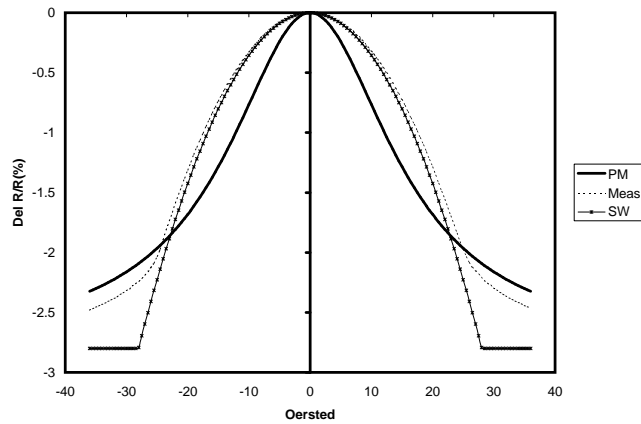


**Fig. 3.10** Measured versus Models,  $150\text{\AA}/8\mu\text{m}$ .



**Fig. 3.11** Measured versus Models,  $250\text{\AA}/35\mu\text{m}$ .





**Fig. 3.12** Measured versus Models,  $385\text{\AA}/20\mu\text{m}$ .

In general, the SW model is closer to measured data within the first  $\pm 20$  Oersted or so. Then, the vector model (VM) is closer to measured data.

## REFERENCES

1. P.A. Holman, "Design Model of Longitudinal Magnetoresistance of Permalloy Prior to Magnetization Reversal," Ph.D. dissertation, University of Texas at Dallas, 2003.
2. E.C. Stoner and E.P. Wohlfarth, "A Mechanism of Magnetic Hysteresis in Heterogeneous Alloys," 1991, IEEE Trans. Magn., 27, No 4, 3475-3518.
3. B.B. Pant, "Scaling in thin magnetoresistive films," JAP, 67(1), 1 January 1990.
4. S. Tumanski, *Thin Film Magnetoresistive Sensors*, IOP Publishing, 2001.

# 4

---

## *Circuits*

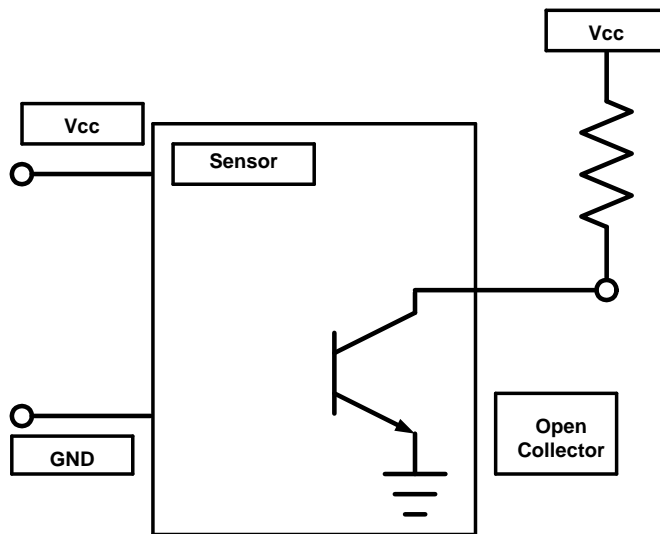
This chapter discusses some aspects of electrical circuits utilized with sensors.

### **4.1 INPUT CIRCUITS**

The input circuit for most sensors is mainly for noise immunity, as well as transient immunity. For input noise immunity, typically a capacitor is placed from the supply pin ( $V_{cc}$  or  $V_{dd}$ ) to ground. The noise section discusses this concept in more depth. Additional input circuits may include a small ( $< 10\Omega$ ) resistor in supply line. The purpose of in-line resistor is to reduce transients on the power line, from reaching the circuit. Further, a “ferrite bead” can be placed in-line of the supply line, to suppress transients and radio frequency (RF) noise. The “ferrite bead” is an inductor, and impedance increases with frequency. Thus, at DC, the resistance is low and power flows, but at high frequency, the bead is high impedance to the noise.

### **4.2 OUTPUT CIRCUITS**

This section discusses output circuits, including open collector/open drain, logic interface, 2-wire, linear, and pulse width modulated (PWM).



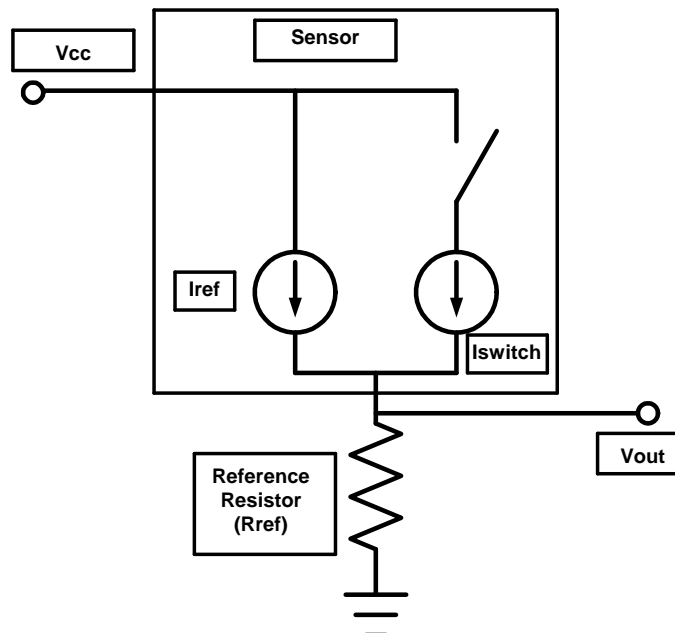
**Fig. 4.1** Open Collector Schematic.

#### 4.2.1 Open Collector/Drain

Open collector/open drain is one of the simplest output circuits available, Fig. 4.1. The concept is the sensor is in one of two possible states, logical 0 or 1, and thus the output is either off or on. A subtlety is defining on and off. Is voltage high on? Or, is current flow on? Typically, the voltage at  $V_{out}$  defines on and off. With no current flow,  $V_{out}$  is equal to the supply voltage ( $V_{cc}$ ). If the output transistor is on, current flowing,  $V_{out}$  is nearly ground. There are two main types of output transistors: bipolar and field effect transistor (FET). A bipolar transistor (typically NPN, open collector) typically has a faster fall time, and handles greater current (typically up to 20mA). The disadvantage of open collector is a higher current requirement, and the voltage across the output transistor, while conducting current (saturation voltage, or  $V_{sat}$ ), is fairly high, on the order of 0.2V. Also, when not conducting current, bipolar transistors have some unintended current (leakage current), on the order of a few nanoamps, which is heavily temperature dependent. Open drain FET output circuits are best used for driving capacitive load, as opposed to a resistor load. Open drain output requires lower drive current, and  $V_{sat}$  is very close to zero (millivolts).

#### 4.2.2 Logic Interface

The Hall Effect Handbook [1] discusses logic interfaces. When that was written, transistor-transistor-logic (TTL) was a popular logic type. TTL logic has the disadvantage of requiring current biasing on the input. More modern logic utilizes CMOS



**Fig. 4.2** Open Collector Schematic.

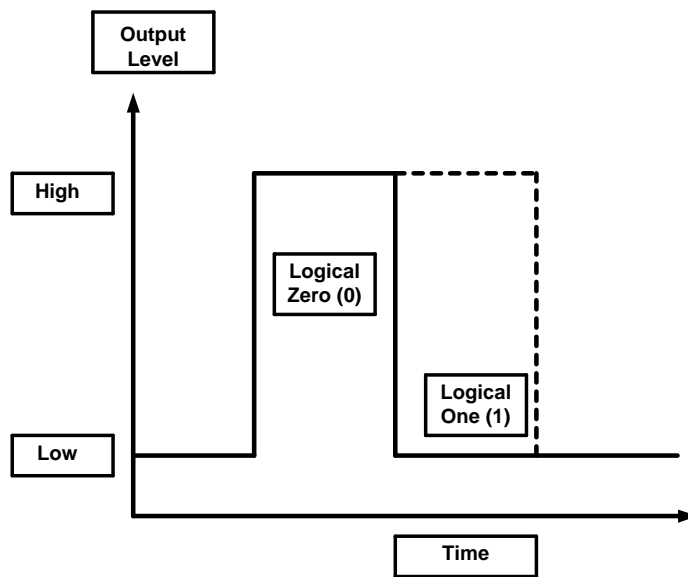
input, and requires essentially zero input current, is only voltage driven. Thus, the  $V_{out}$  node from open collector/open drain usually can feed directly into logic gates.

#### 4.2.3 2-Wire

2-wire output circuits are utilized in a wide range of applications. A major advantage is that less wiring is required. Also, earlier magnetic sensing methods, such as variable reluctance, is inherently 2-wire. Thus, as active devices displace these other sensing methods, the circuit interface (2-wire) is sometimes propagated. The basic concept is shown in Fig. 4.2. A constant current source ( $I_{ref}$ ), is sent to a reference resistor ( $R_{ref}$  or  $R_{load}$ ), creating a reference voltage. A common current value is 7mA for automobiles, and 4mA for industrial applications. The  $R_{load}$  is typically between 100 and 300  $\Omega$  for automotive. Care should be taken that the appropriate resistance values are utilized, such that:

$$V_{cc} - (I_{ref} \cdot R_{load}) > V_{min} \quad (4.1)$$

with  $V_{min}$  around 3.3 volts. Next,  $V_{out}$  goes directly into some detection circuit, such as a comparator, to create a logic level. Typically, the reference resistor is between the sensor and ground, but may be between supply and the sensor.



**Fig. 4.3** Pulse Width Modulated (PWM) Detection.

#### 4.2.4 Linear

The Hall Effect Handbook covers linear output circuits well. The important concept is driving the load impedance. If the load is  $1\text{ k}\Omega$ , with  $5\text{ V}$  supply, the circuit must be able to deliver  $5\text{ mA}$  to the load. Also, if the load is from the output of the circuit to ground, the circuit must be able to source the appropriate current. With a load from the output to supply, the circuit must be able to sink the current.

#### 4.2.5 Pulse Width Modulated

A method of transmitting sensor information is pulse width modulated (PWM). PWM may be linear, digital, 2-wire, or the like. Thus, PWM is a communication mode, rather than an output circuit type. A simple digital PWM signal is shown in Fig. 4.3. One common application for PWM is 2-wire wheel speed detection. As the poles of a ring magnet pass the sensor, the output is low-high-low, with a specific time duration. If the magnet rotates the opposite direction, the pulse is still low-high-low, but the pulse width increases, notifying the controller the wheel is going backwards.

### 4.3 SIGNAL CONDITIONING

A wide range of circuits are utilized in signal conditioning for sensors. Two topics are discussed in the section: amplifiers and comparators.

### 4.3.1 Amplifier

Amplifiers are one of the main building blocks of analog circuits. An amplifier is an electric circuit which can give a larger signal at the output, than is supplied at the input. An amplifier can shift the level of a signal, as well as a wide range of other useful signal conditioning actions. Several good books exist on the topic, such as Stout and Kaufmann [2]. Also, several useful application notes exist on the internet.

### 4.3.2 Comparators

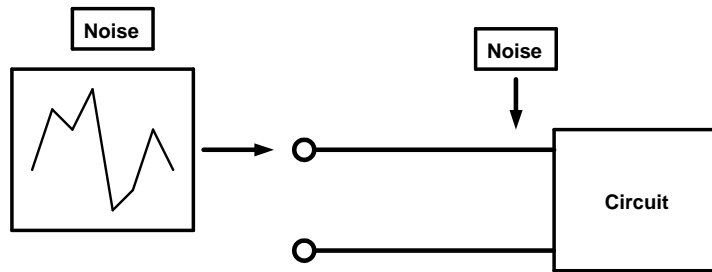
As the name suggests, a comparator is a device that compares two signals. With input A higher than input B, the output is high; and input B higher than input A gives a low output (for example). This ability is of great value in circuit design. Some amplifiers can be used as a comparator.

## 4.4 POWER CONDITIONING: REGULATION

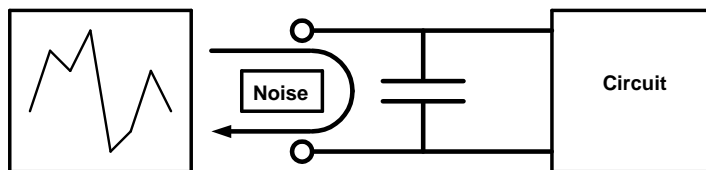
Sensor performance is dramatically effected by the power applied. For example, excessive voltage may destroy the device. Thus, care is required to protect the sensor, and provide the required voltage and current. This function is performed by the power conditioning circuit (regulator). Regulators may be external devices (such as 78XX series), or included on the sensor (such as a bandgap regulator [3]). For external regulators (78XX series), replace the XX by the voltage required, thus a 7805 is a 5 volt regulator. A few points of interest, to make an external regulator successful. First, capacitors are often required on the input and output. A larger capacitor ( $\sim 10\mu\text{F}$ ) is on the input, and a small capacitor ( $\sim 0.1\mu\text{F}$ ) on the  $V_{out}$  side, to minimize electrical ripple. Second, typically a load is required for proper performance, ie. do not connect the regulator, without a load, and expect the regulated 5 volts at the output. Next, take caution to use the proper voltage and current required by the regulator. For example, if the regulator is capable of supplying 100 mA, do not apply a load requiring 1 A. Also, there is some voltage lost required. In a simple regulator, there is a “dropout” voltage, across the regulator. If 5 volts is the output voltage, typically the requirements are 2 volts higher than the output, thus 7V is the minimum at the input.

## 4.5 NOISE

Noise is important for many electronic systems, such as communications and sensors. The capabilities of electrical systems are ultimately limited by the noise in the system. Noise may be defined as any undesired signal in a system. Noise may be offset of a bridge, or reception of a radio station. Noise may be in two main categories: correlated and fundamental. Correlated noise is a result of the system creating or absorbing noise from a known source, such as turning on a vacuum cleaner



**Fig. 4.4** Noise on Power Lines.



**Fig. 4.5** Noise Reduction from Capacitor.

messing up radio reception. One can improve correlated noise, such as turn off the vacuum cleaner. Fundamental noise is due to the discrete electron structure of atoms. Fundamental noise is always in a system, but may be optimized by the designer. Correlated noise is often more difficult to resolve. The book by Ott [4] covers the topics of noise quite well. Additionally, Aldert van der Ziel is widely known as one, if not the, leading expert on noise [5]. Noise is often called noise because if amplified, and put through a speaker, it sounds like hissing.

#### 4.5.1 Power Supply Noise

This subsection very briefly discusses power supply noise. Noise may arrive at the sensor along the power lines, Fig. 4.4. Then, a capacitor is added from the power line to ground. A capacitor has an impedance which is proportional to the inverse of the frequency ( $1/f$ ), thus at higher frequencies, the capacitor appears as a short, and the noise bypasses the sensor, Fig. 4.5.

#### 4.5.2 Magnetic Noise

As discussed in the introduction, magnetism is created at the subatomic level. In many ferromagnetic materials, the structure is polycrystalline, with a (at least initially) random magnetization. In other words, the small interacting particles group together on an intermediate atomic type level. A grouping of interrelated small particles is

referred to as a domain. As the applied field is varied, a different grouping of particles is seen. The energy associated with the domains may be released with different applied field configurations, and is seen as noise. This type of noise is known as Barkhausen noise. Permalloy “chirp” may be considered a Barkhausen noise phenomena.

#### 4.5.3 Metallic (Faraday) Cage

One technique to improve electrical noise is the use of a metallic (Faraday) cage. An electrical circuit, placed in metal box, is nearly impervious to external electrical noise. The noise may be considered to be shorted past the circuit. One obvious question would be, “How do you power a circuit in a cage?” If the power is entered through the cage, there is a concern noise will be introduced on the power lines. Another possibility is to battery power the circuit in the cage. A battery is a low noise power supply.

#### 4.5.4 Mu Metal Cage

A technique similar to a Faraday cage, but concerned with magnetic noise (such as from electric motors), is the so called “Mu Metal” cage, where the Mu is for high permeability ( $\mu$ ). The circuit will be mostly shielded from external magnetic fields. This may be of value for Permalloy sensors.

### REFERENCES

1. *Hall Effect Transducers. How to Apply Them as Sensors*, Honeywell (MicroSwitch) Publishing, 1982.
2. D.F. Stout and M. Kaufman, *Handbook of Operational Amplifier Circuit Design*, McGraw Hill, 1976.
3. A.B. Grebene, *Bipolar and MOS Analog Integrated Circuit Design*, Wiley-Interscience, 1984.
4. H.W. Ott, *Noise Reduction Techniques in Electronic Systems, 2nd ed.*, Wiley-Interscience, 1988.
5. A. van der Ziel, *Noise In Measurements*, Wiley-Interscience, 1976.



# 5

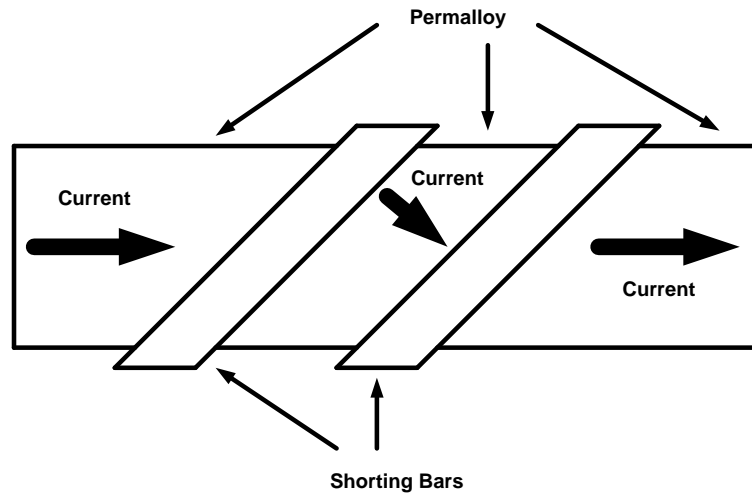
---

## *Applications*

Within this chapter, several applications are discussed, to give the reader some ideas.

### **5.1 MAGNETOMETER**

Most people are familiar with the idea that the earth has a magnetic field, and magnetic north is near the north pole. Also, the earth's magnetic field is very small, on the order of 0.25 to 0.5 Gauss (0.025 - 0.05 mT). So, if there is a device which measures low field values, and direction, a compass is possible. Old style compasses use a magnetized needle, often suspended in water, floating on a piece of cork. Modern compasses utilize magnetic films, such as Permalloy, to detect the earth's magnetic field. Since the magnetic field values are small, and the  $\Delta R/R$  curve of Permalloy is basically flat around zero applied field, a different approach is necessary. Remember, the  $\Delta R/R$  calculation is performed as the  $\cos^2(\theta)$  of the angle between the current flow, and the internal magnetization. Additionally, the most sensitive portion of the  $\Delta R/R$  curve occurs around  $45^\circ$  between the magnetization direction, and the current flow. Assuming the magnetization is in line with the mechanical length of the resistor, if the current could be "steered" to  $45^\circ$ , a low field sensitive sensor could be created. The device which has the current flow at  $45^\circ$  to the magnetization, with no applied field is referred to as a barber-pole device. This "steering" of the current is performed by placing "shorting bars" on the Permalloy. The shorting bars may be aluminum, and have a much lower electrical resistance ( $0.02\Omega/\square$  for aluminum versus  $10\Omega/\square$  for Permalloy), and are placed at  $45^\circ$  relative to the Permalloy resistors, Fig. 5.1.

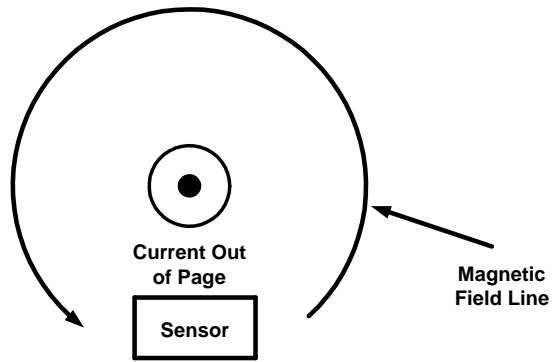


**Fig. 5.1** Barber Pole Configuration.

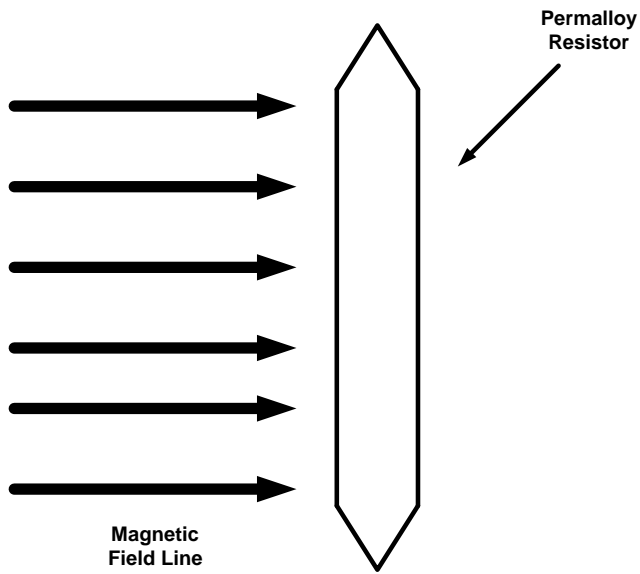
Now, the current and magnetization are at  $45^\circ$  with zero applied magnetic field, a small field causes an signal.

## 5.2 CURRENT

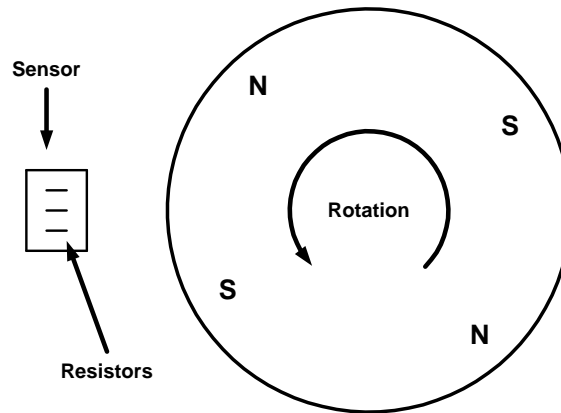
Current is an important electrical value to measure. One of the simplest methods is an in-line current meter, but this requires the line to be broken, and current meters are sometimes expensive. Another method is to place a small resistor ( $< 1\Omega$ ) in line, and measure the voltage across this resistor, referred to as a sense resistor. A potential issue is that energy is lost in the sense resistor. For some applications, an alternative with advantages is a non-invasive current sensor. To begin the conversation, remember that a current carrying wire creates a field  $\vec{H} = I/(2\pi\rho)\hat{\phi}$ , where  $I$  is the current in the wire,  $\rho$  is the distance from the wire, and  $\hat{\phi}$  is the circular direction. Thus, a current in a wire creates “circles” of magnetic field, where the amplitude falls off with a  $1/r$  relationship, and the direction follows the right-hand-rule. Since the sensor is small, on the order of less than a millimeter, the sensor is placed such that the field is essentially uniform across the sensor, Fig. 5.2. The sensor should be placed to maximize the response to the field from the wire (Fig. 5.3).



**Fig. 5.2** Magnetic Field Lines with Sensor.



**Fig. 5.3** Permalloy Resistor with Perpendicular Field.



**Fig. 5.4** Speed Sensor, Edge On Configuration.

### 5.3 SPEED

This section talks about speed sensors, specifically detection of a rotating ring magnet, such as wheel speed for anti-lock brakes. The general concept is a disk (ring), covered by permanent magnet material on the outer portion. Two main version are considered: edge-on and face-on detection.

#### 5.3.1 Edge-On

Edge-on detection is performed with the edge of the sensor near the rotating ring magnet. Edge-on usually does not allow as large of airgap. The field from the ring magnet gives a field in a direction, as well as a rotating field, depending on airgap, Fig. 5.4.

Edge on devices may utilize a “diamond” bridge, to minimize the effect of “chirp” (Fig. 5.5). This bridge configuration tends to use the rotating magnetization, instead of hard axis response, although either (or both) types may be utilized, as shown in the figure.

#### 5.3.2 Face-On

Face-on sensing is performed with the face of the sensor near to the edge of the ring magnet. Typically, face-on senses at the greatest airgap, (Fig. 5.6).

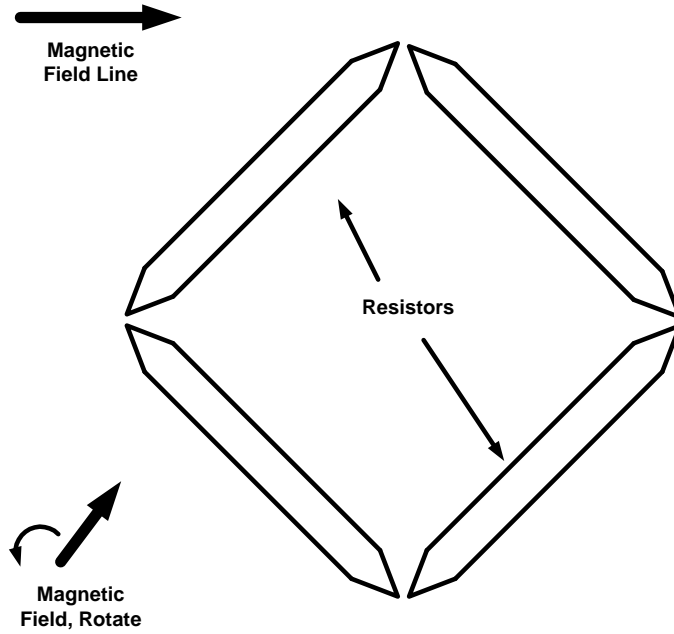


Fig. 5.5 "Diamond" Configuration Bridge.

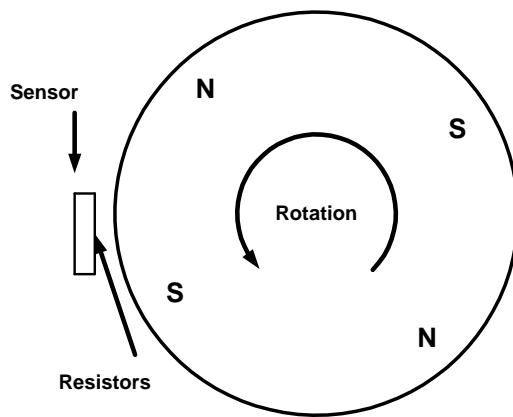
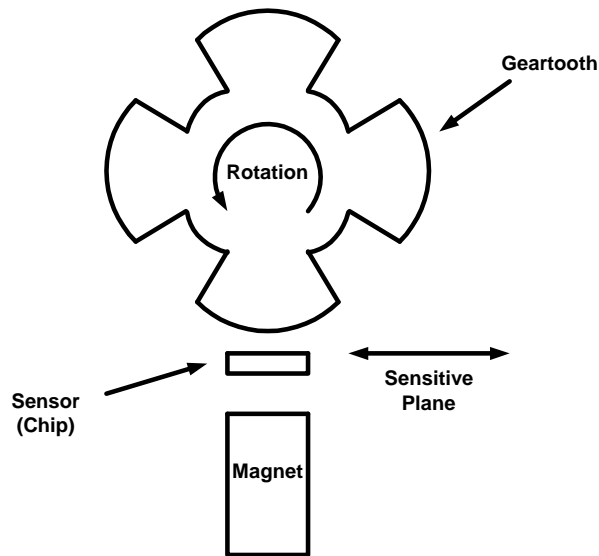


Fig. 5.6 Speed Sensor, Face On Configuration.



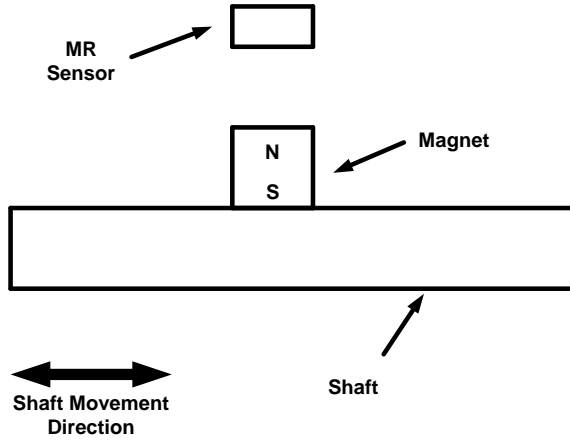
**Fig. 5.7** Geartooth Sensor.

#### 5.4 GEARTOOTH

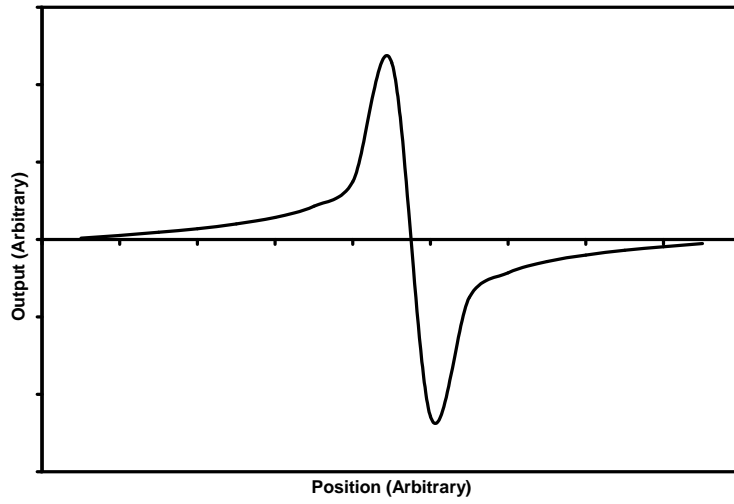
Geartooth sensors are named from the targets to be sensed, which have teeth, and appear similar to a gear. A geartooth sensor has a magnet within the sensor, as opposed to ring magnet sensor, where the target is a magnet. The magnet integrated in the geartooth sensor creates a magnetic field, and the target is ferromagnetic. The target modifies the magnetic field, changing the flux at the sensor. This change in flux creates a change in resistance of the magnetoresistors, giving a signal. This signal is related to the position of the teeth as the target rotates around, which is an indication of the position of the value of interest, Fig. 5.7

#### 5.5 LINEAR POSITION

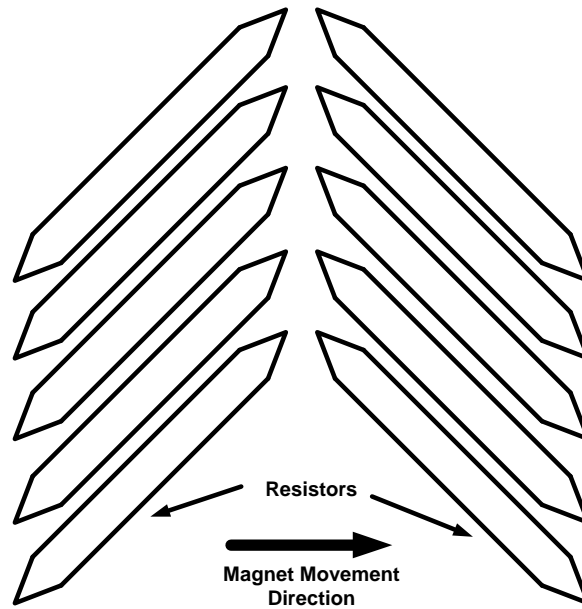
Another important measurement is linear position, for example, the location of a shaft. A magnet can be attached to the device of interest, and a MR sensor placed near the magnet, Fig. 5.8. As the shaft moves past the MR sensor, a signal is produced, such as Fig. 5.9. A typical linear position bridge might appear as Fig. 5.10. An array of sensors are often utilized in a Honeywell patented (such as US 5,589,769) system, to measure linear position to a high resolution.



**Fig. 5.8** Linear Position System.



**Fig. 5.9** Linear Application Sensor Output Example.

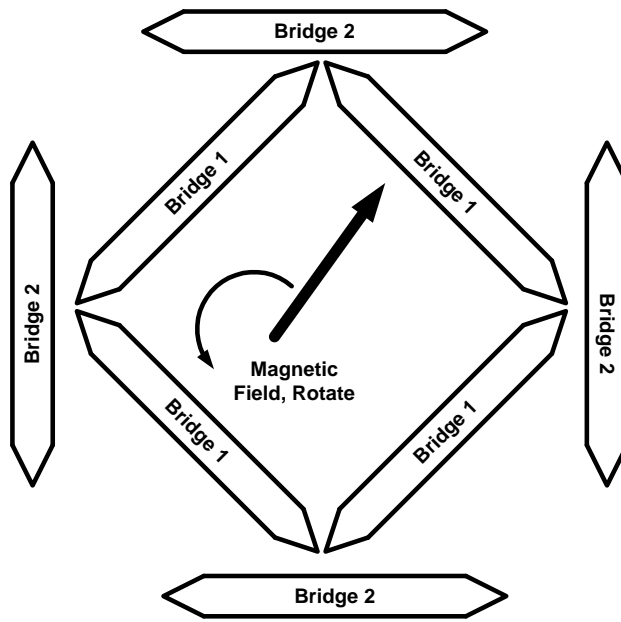


**Fig. 5.10** Linear Application Bridge.

### 5.6 ANGLE POSITION

Angle position sensors are utilized to measure the rotary position of a device, for example, a steering wheel. As mentioned above, Permalloy has a response ( $\Delta R/R$ ) which is  $\cos^2(\theta)$ . Also,  $\cos(\theta - 90^\circ) = \sin(\theta)$ , and since Permalloy is an even function material,  $45^\circ$  physical degrees gives a sin versus cos. So, bridge 1 gives an output that is a representative of  $\sin^2 \theta$ , and bridge 2 is the  $\cos^2 \theta$ , thus, some processing provides the angle ( $\theta$ ). Permalloy angle position sensors are limited to a range of  $\pm 90^\circ$ , because the function is even ( $\cos^2 \theta$ ).





**Fig. 5.11** Rotary Application Bridge.

# *Appendix A*

## *Units and Conversions*

### A.1 MAGNETIC UNITS

Quantity	Symbol	Unit, CGS	Unit, SI	(SI)/(CGS)Ratio*
Magnetic Flux	$\Phi$	maxwell	weber, Wb	$10^8$
Magnetic Flux Density	B	gauss, G	tesla, T	$10^4$
Magnetic Field Strength	H	oersted, Oe	ampere/meter, A/m	$4\pi/10^3$
Magnetomotive Force	F	gilbert, Gb	ampere, A	$4\pi/10$
Permeability of Freespace	$\mu_o$	(unity)	henry/meter, H/m	$10^7/4\pi$
Reluctance	$\mathcal{R}$	gilbert/maxwell	1/henry, $H^{-1}$	$4\pi/10^9$
Permeance	P	maxwell/gilbert	henry, H	$10^9/4\pi$

(\* Quantity in SI units must be multiplied by this ratio to convert to CGS units.)

Quantity	Symbol	Name	Abbr.
Current	I or i *	ampere	A or a
Charge	Q or q *	coulomb	C
Voltage	V or v *	volt	V or v *
Power	P	watt	W or w
Resistance	R **	Ohm	$\Omega$
Reactance	X **	Ohm	$\Omega$
Impedance	Z **	Ohm	$\Omega$
Conductance	G **	Mho or Siemens	$\mathcal{U}$
Admittance	Y **	Mho or Siemens	$\mathcal{U}$
Susceptance	B **	Mho or Siemens	$\mathcal{U}$
Capacitance	C	Farad	F or f
Inductance	L	Henry	H or h
Frequency	F or f	Hertz	Hz
Period	T	seconds	s

## A.2 ELECTRICAL UNITS

\* Capital letter general used for peak RMS or DC value; small letter used for instantaneous values.

\*\* Small letter generally used for the internal value of a component.

# *Appendix B*

## *Types of Magnetism*

There are five major types of magnetism, depending on the response of a material to an externally applied magnetic field. The types are paramagnetism, diamagnetism, ferromagnetism, ferrimagnetism, and antiferromagnetism. Each type is explained in more detail below.

### **B.1 PARAMAGNETISM**

Essentially all materials exhibit paramagnetism. Each atom has orbiting electrons, which create a magnetic field that is small. Additionally, the next neighbor atom has a magnetic field, and the atoms tend to align such that the net field is close to zero. Furthermore, the magnetic relative permeability,  $\mu_r$ , is approximately one.

### **B.2 DIAMAGNETISM**

Few materials show diamagnetism. Essentially, diamagnetism is negative magnetism; the electrons in the atoms align themselves such that they will not allow an applied field to enter into the material. This is repulsive magnetism, and is useful for magnetic levitation (maglev).

### **B.3 FERROMAGNETISM**

Some materials have ferromagnetic properties, mainly nickel, iron, cobalt, and their alloys. The distinguishing factor for ferromagnetism is the atoms have a coherent magnetization. Individual atoms align with an applied field, in concert, to create large effects. The relative permeability is typically very large, possibly thousands. Above the Curie temperature, ferromagnetic materials have paramagnetic properties. This book is predominately concerned with ferromagnetic materials (ermalloy).

### **B.4 FERRIMAGNETISM**

Ferrimagnetism is quite similar to ferromagnetism. The difference between ferro- and ferri- magnetism is subtle, not even being theorized until 1948. This difference is that ferrimagnetism is caused by (at least) a dual lattice interaction. Thus, ferrimagnetic materials are compounds, such as cobalt and oxygen, whereas ferromagnetic materials may be only alloys (Permalloy is an alloy). The main ferrimagnetic devices of interest are ferrite magnets. Ferrite magnets have a major industrial utilization as a low cost magnet material, popularized by “refrigerator magnets.”

### **B.5 ANTIFERROMAGNETISM**

More materials exhibit antiferromagnetic properties than ferrimagnetic properties, but they are of less industrial concern. Antiferromagnetism is demonstrated in a material by an externally applied magnet field causing the internal magnetization to be antiparallel, in opposition to the applied field. All antiferromagnetic materials are ionic compounds, often of manganese. One major application is for the development of unique magnetically sensitive materials, such as giant magnetoresistance (GMR) materials, utilized in modern hard disk drive read heads.

# *Appendix C*

## *What is a Sensor?*

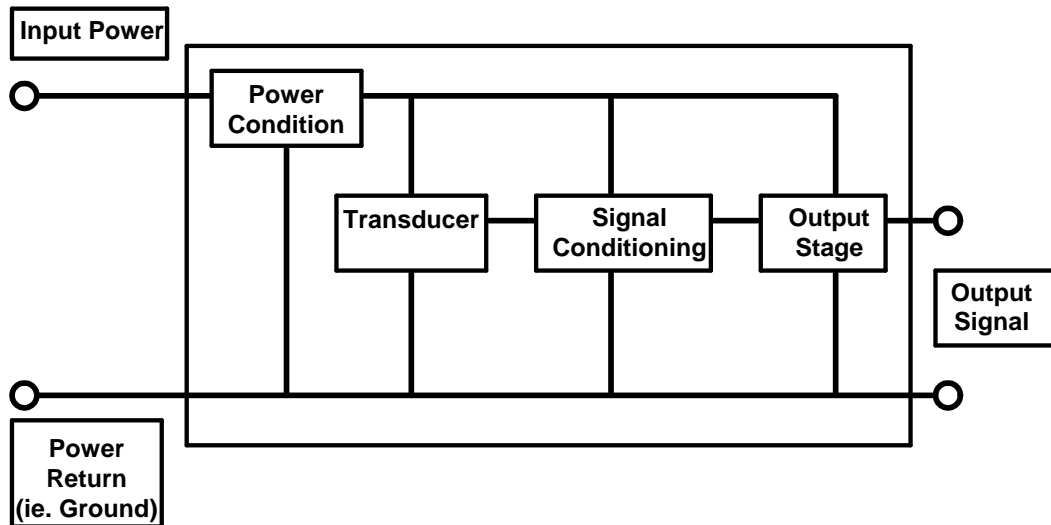
This appendix discusses how sensors are defined. The excellent book by Fraden [1] goes to a much greater extent defining a sensor. Also, Fraden's work covers a much wider range of sensing technologies than magnetic sensors.

### **C.1 PARTS OF A SENSOR**

A sensor is a device that gives a useable signal, related to some physical stimulus. The parts of a sensor may include, but are not limited to: a transducer, power conditioning, signal conditioning, and output electronics. Figure C.1 is a simplified representation of the components of a sensor. Please read the diagram from left to right. The circles are possible external connections.

#### **C.1.1 Input Power**

The first component of the sensor is the input power. This power comes from some external source, such as a battery, a power supply, and the like. This power source should be sufficient to provide the appropriate amount of voltage and current. Typical values of voltage for the types of sensors discussed herein is in the range of 4-30 volts, and current requirements of 1-30 mA. The devices detailed are typically not intended for 110V AC.



**Fig. C.1** Components of a Sensor.

### C.1.2 Power Return

The next component of the sensor is the power return. Typically, this would be the ground, or common, of the input power supply. Two-wire devices might be different, and are covered at greater length in the circuit chapter.

### C.1.3 Power Condition

The power may need to be conditioned to be used in the sensor. If the device is ratiometric, such as for the input to an analog to digital converter (ADC) or a digital signal processor (DSP), there is really no power conditioning, perhaps a capacitor from power to ground. In many other cases, there needs to be conditioning of the power. Internally, the device might work at 3 volts for power constraints and the like, but the applied voltage may be 12 volts, such as in an automobile, or a 24V industrial power supply. This power conditioning may be performed by an integrated circuit, or an external device. The conditioning might be as simple as a bandgap regulator for bipolar integrated circuits, or a pulse-width modulated DC-DC converter. Once again, this will be discussed at greater detail in the chapter on circuits.

### C.1.4 Transducer

A transducer is a device that takes some physical attribute (temperature, humidity, etc.), and converts it into an electrical signal. The transducer is the most important portion of the sensor, in fact some “sensors” are merely transducers with packaging.

The transducer may be a temperature device (RTD, thermocouple, thermostat), optical (photoelectric), magnetic (Hall Effect or magnetoresistive), or one of a large number of devices that take some physical attribute, and create an electrical signal. Typically the performance of the sensor is greatly impacted by the capabilities of the transducer.

### **C.1.5 Signal Conditioning**

The signal from the transducer typically needs to be conditioned in some fashion to be utilized by the external world. This signal conditioning may be as simple as a set point, such as a thermostat. Many transducers give a small electric signal, and thus need to be amplified. Or, the transducer response may not be linear, and the signal conditioning circuitry needs to linearize the signal. More information on signal conditioning is given in the circuit chapter.

### **C.1.6 Output Stage**

Finally, the sensor interacts with the external world, such as other electronics. This requires an output stage, which is basically a translation of the signal into a form the external system understands. The output stage maybe a simple on-off output to turn on a light, or a linear output, such as the level of gas in a gas tank. The output stage may be digital, open collector/open drain (NPN, PNP, DMOS, etc.), push-pull output (class A, class AB, etc.), 2-wire (4-20 mA), pulse-width modulated (PWM), or frequency modulated, as well as others.

## **C.2 SPECIFYING A SENSOR**

Specifying a sensor is covered well by Fraden. For general sensors, several different topics are of interest: span, full scale output (FSO), accuracy, offset, hysteresis, linearity, saturation, repeatability, dead band, resolution, impedance, frequency and phase response, and many other things.

### **C.2.1 Span**

Span is the range of input the sensor will allow. For example, an electrical amplifier typically only allows inputs from positive supply to negative supply. Input ranges outside of span may or may not damage the device.

### **C.2.2 Full Scale Output**

Full Scale Output (FSO) is the range of output from the device. A simple example is an amplifier that only has a output swing from 1-4 V.



### C.2.3 Accuracy

Accuracy is a measure of how close an output is to the “correct” value. The correct value would be from a standard source. For example, a home thermometer might read 75°, but the actual temperature, say from the television, is 74°, thus, accuracy is 1°. Accuracy is often given as a range,  $\pm 1^\circ$  or  $\pm 0.05\%$ .

### C.2.4 Repeatability

Repeatability is somewhat related to accuracy. Repeatability is defined as: with the same input, the measurement is the same. Using the temperature example, if a home thermometer says 75°, and tomorrow has the same reading, with identical conditions, then the device is repeatable.

### C.2.5 Hysteresis

Hysteresis is the difference in response, depending on the direction of the input. A home thermostat utilizes hysteresis to turn the heat on. If the temperature is below 75°, for example, the heat is on. With the temperature above 77°, the heat is off. In between, the heat is on or off depending on if the temperature is rising or falling.

### C.2.6 Linearity

Linearity is deviation of the output of a sensor from a straight line.

### C.2.7 Saturation

Saturation is the inability of the output of a sensor to continue to change, with more input. For example, an amplifier typically does not have the ability for the output to go past the supply rail, so more input, the output stops at the rail.

### C.2.8 Offset

Offset is a repeatable difference between the actual condition, and the measurements. From the temperature example, if a home thermometer is always 3° higher than actual, then, there is an offset of 3°.

### C.2.9 Resolution

Resolution is the smallest amount of input change, to modify the output.

### C.2.10 Dead Band

Dead band is a range of input, over which the output is not sensitive to the input.

### **C.2.11 Impedance**

Impedance, input and/or output, is the electrical measurement of a sensor.

### **REFERENCES**

1. J. Fraden, *Handbook of Modern Sensors, 2nd ed*, AIP Press, 1997.

# Appendix D

## Permanent Magnet Calculations

This chapter describes the development of the closed form solution to a linear permanent magnet in a region free from ferrous material (“freespace”).

### D.1 DERIVATION

The following is the derivation of the field from a parallelepiped “perfect” permanent magnet. The method uses electrostatic equivalence between electrical and magnetic equations. A “perfect” magnet is defined such that the magnet is “hard,” ie. superposition holds, and the relative permeability  $\mu_r$  is exactly 1. This is a very good representation of many modern magnetic materials, such as *SmCo* and *NdFeB*. *AlNiCo* is not modelled well by this method.

Begin with the classic electric field from a point charge (D.1) [1]:

$$\vec{\mathbf{E}} = \frac{Q}{4\pi\epsilon_o|\vec{\mathbf{R}}|^2} \hat{\mathbf{a}} \quad (\text{D.1})$$

Where:

$\vec{\mathbf{E}}$  is the electric field from the point charge

$Q$  is the amount of charge at the point  
 $\epsilon_o$  is the permittivity of freespace  
 $\vec{\mathbf{R}}$  is the vector from the point charge to the point of interest  
 $\hat{\mathbf{a}}$  is the unit vector of  $\vec{\mathbf{R}}$ .

Now, create a line of charge by an definite integral over the rectangular coordinates  $\langle -a, +a \rangle$  inclusive (D.2):

$$\vec{\mathbf{E}}_{line} = \int_{-a}^{+a} \frac{dQ}{4\pi\epsilon_o|\vec{\mathbf{R}}|^2} \hat{\mathbf{a}} \quad (\text{D.2})$$

Where:

$dQ$  is the charge per unit length.

Next, create a rectangle by sweeping  $\vec{\mathbf{E}}_{line}$  over  $\langle -b, +b \rangle$  in a perpendicular direction (D.3):

$$\vec{\mathbf{E}}_{square} = \int_{-b}^{+b} \int_{-a}^{+a} \frac{dQ}{4\pi\epsilon_o|\vec{\mathbf{R}}|^2} \hat{\mathbf{a}} \quad (\text{D.3})$$

In rectangular coordinates, and converting to magnetic flux density (D.4):

$$\vec{\mathbf{B}}(x, y, z) = \frac{B_r}{4\pi} \int_{-b}^{+b} \int_{-a}^{+a} \frac{(x' - x)\vec{x} + (y' - y)\vec{y} + (z' - z)\vec{z}}{((x' - x)^2 + (y' - y)^2 + (z' - z)^2)^{3/2}} dx dy \quad (\text{D.4})$$

Where:

$B_r$  is a basic material property, the residual magnetism

$(x', y', z')$  is the location of the point of interest (where the field value is desired)

$(x, y, z)$  is the center of the magnetic "plate."

To find the field from a magnet, the charge is assumed to be only on the ends of the magnet, thus, take (D.4) and subtract (D.4) with a  $\vec{z}$  offset of the length of the magnet ( $L$ ):

$$\vec{\mathbf{B}}(x, y, z) = \frac{B_r}{4\pi} \left( \int_{-b}^{+b} \int_{-a}^{+a} \frac{(x' - x)\vec{x} + (y' - y)\vec{y} + (z' - z)\vec{z}}{((x' - x)^2 + (y' - y)^2 + (z' - z)^2)^{3/2}} dx dy - \int_{-b}^{+b} \int_{-a}^{+a} \frac{(x' - x)\vec{x} + (y' - y)\vec{y} + (z' - (z + L))\vec{z}}{((x' - x)^2 + (y' - y)^2 + (z' - (z + L))^2)^{3/2}} dx dy \right) \quad (\text{D.5})$$

The solution to the plate of charge, equation (D.4), is found in McCaig [2]. The solution is reprinted for completeness.

$$B_x = \frac{B_r}{4\pi} \text{Log} \left[ \frac{y + b + ((y + b)^2 + (x - a)^2 + z^2)^{1/2}}{(y - b) + ((y - b)^2 + (x - a)^2 + z^2)^{1/2}} \times \right]$$

$$\left. \frac{(y-b) + ((y+b)^2 + (x+a)^2 + z^2)^{1/2}}{(y+b) + ((y+b)^2 + (x+a)^2 + z^2)^{1/2}} \right] \quad (\text{D.6})$$

$$B_y = \frac{B_r}{4\pi} \text{Log} \left[ \frac{(x+a) + ((y-b)^2 + (x+a)^2 + z^2)^{1/2}}{(x-a) + ((y-b)^2 + (x-a)^2 + z^2)^{1/2}} \times \frac{(x-a) + ((y+b)^2 + (x-a)^2 + z^2)^{1/2}}{(x+a) + ((y+b)^2 + (x+a)^2 + z^2)^{1/2}} \right] \quad (\text{D.7})$$

$$B_z = \frac{B_r}{4\pi} \left[ \tan^{-1} \left( \frac{(x+a)(y+b)}{z((x+a)^2 + (y+b)^2 + z^2)^{1/2}} \right) + \tan^{-1} \left( \frac{(x-a)(y-b)}{z((x-a)^2 + (y-b)^2 + z^2)^{1/2}} \right) - \tan^{-1} \left( \frac{(x+a)(y-b)}{z((x+a)^2 + (y-b)^2 + z^2)^{1/2}} \right) - \tan^{-1} \left( \frac{(x-a)(y+b)}{z((x-a)^2 + (y+b)^2 + z^2)^{1/2}} \right) \right] \quad (\text{D.8})$$

## REFERENCES

1. W.H. Hayt, *Engineering Electromagnetics, 5th ed.*, McGraw-Hill, 1989.
2. M. McCaig *Permanent Magnets in Theory and Practice*, Pentech Press Limited, 1977.

# Glossary

**Anisotropic** Anisotropic is a term often discussed with Permalloy. The best way to describe anisotropic, is by comparison. The opposite of isotropic is anisotropic. Isotropic simply means the same in every direction. Thus, anisotropic means that it depends on the direction. For Permalloy, the magnetoresistance is dependent on the direction of the applied field.

**$B_{chirp}$**  The magnetic field value where the magnetoresistance curve “snaps” back to zero  $\Delta R/R$ .  $B_{chirp}$  is valuable in the modeling of films, for example, the saturation value of a film is essentially  $B_{chirp}$  plus 20 Gauss.

**Barber-pole** A Permalloy device, with shorting bars, to have the current at  $45^\circ$  to the magnetization, with zero applied field. This configuration is very sensitive at low magnetic field values, and is used in a magnetometer: for a compass, or road edge detection for automated highways.

**Barkhausen Noise** Fundamental magnetic noise due to discrete magnetic domain reversals in a magnetic material. Permalloy “chirp” may be considered a Barkhausen noise event.

**Coercivity** The externally applied magnetic field required to bring the resultant (of the externally applied, and intrinsic field from the material) to zero.

**Easy Axis** Easy Axis is the preferred direction of magnetization of a film, created during the deposition of the film on a wafer. Typically, the mechanical length of the resistor, and electrical current flow, is generally in the direction of the Easy Axis.

- Flicker Noise** A noise source where the amplitude of the noise is a function of frequency. Typically, the amplitude is a function of 1/frequency.
- Geartooth** A ferromagnetic target, attached to something to be measured, such as a crank shaft.
- Hard Axis** Hard Axis is generally perpendicular to the Easy Axis, typically across the short (narrow) dimension of a resistor.
- Johnson Noise** Alternate term for thermal noise. See thermal noise.
- Magnetometer** A device for sensing low magnetic field values, and direction. Often utilized for compasses.
- Pink Noise** A noise source where the amplitude of the noise is a function of frequency. Typically, the amplitude is a function of 1/frequency.
- PPM** Parts per million is a convenient term for small changes, such as temperature coefficient of resistance (TCR). 10,000 ppm/°C equals 1%/°C.
- Pulse Width Modulation** Pulse Width Modulation is an output which switches states, and switches back (such as low-high-low), and the information is transmitted by the length of time of the pulse. For example, an output that is low-high-low for 100 microseconds is a south pole, 200 microseconds for north pole.
- Quadrature** When two signals are out of phase of 90°. This allows margin to tell which signal is leading or lagging.
- Right-Hand Rule** A simple method of determining the effect of certain types of actions. Take the right hand, if the action of rotating the fingers points the thumb up, then, the reaction is in the direction of the thumb. For a simple example, most mechanical screws are right-hand rule, so if the screw is rotated counter clockwise, the screw follows the thumb, and will be driven into the direction of the thumb.
- Shot Noise** Noise created by current flow being restricted to one direction, such as in a p-n junction (diode). Shot noise ( $\overline{v^2} = 2qI$ , where q is the charge of an electron, and I is the current through the junction).
- Stoner-Wohlfarth** Stoner-Wohlfarth (SW) is the traditional modeling method for magnetoresistance.
- TCR** Temperature Coefficient of Resistance. The electrical resistance of a material is often a function of temperature. Most metals have a positive TCR, ie. the resistance increases at higher temperatures. TCR is often given in percent change per degree Centigrade (%/°C), or if the value is small, TCR is often in parts per million per degree Centigrade (ppm/°C), also see PPM.
- Thermal Noise** Noise typically created by resistors such that the amplitude is independent of frequency (white noise), and the amplitude is related to the temperature of the resistor. (Thermal noise is interchanged with Johnson noise.) Thermal noise ( $\overline{v^2} = 4kTR$ , where k is a constant (Boltzman), T is the temperature of the resistor (Kelvin), R is the resistance of the resistor).
- TTL** Transistor-transistor-logic (TTL) was a popular logic type in the 1980's. TTL logic uses (typically) bipolar transistors, which require current biasing.

**White Noise** A noise source which the amplitude of the noise is independent of the frequency of the noise. Thermal noise is a white noise source.

**Vsat** Saturation voltage of a bipolar transistor or a field effect transistor.



# *Acronyms*

AMR	Anisotropic Magnetoresistance (interchangeable with MR)
BN	Barkhausen Noise
CMOS	Complementary Metal Oxide Semiconductor
EA	Easy Axis
FET	Field Effect Transistor
FSO	Full Scale Output
GMR	Giant Magnetoresistance
HA	Hard Axis
HDD	Hard Disk Drive
ML	Mechanical Length, of the resistor
MOSFET	Metal Oxide Semiconductor, Field Effect Transistor
MR	Magnetoresistance (interchangeable with AMR)
PM	Proposed Model
PML	Perpendicular to Mechanical Length
PPM	Parts Per Million
PWM	Pulse Width Modulated (or Modulation)

RF	Radio Frequency
SW	Stoner-Wohlfarth
TCR	Temperature Coefficient of Resistance
TTL	Transistor Transistor Logic
VCR	Voltage Coefficient of Resistance
VM	Vector Model