

Pressure and Force Sensors

Piezoresistive Technology

PIEZORESISTIVE TECHNOLOGY

Background

In the late 1950's, Honeywell's Corporate Technology Center completed basic research on the piezoresistive properties of silicon diffused layers. The first Honeywell application of the piezoresistive device was a solid state accelerometer for the Avionics Division. SSED (Solid State Electronics Division) was formed in the mid-1960's as an internal facility devoted to solid state technology development for application in Honeywell systems. One of the first areas of development was the continued study of piezoresistive properties of silicon layers and development of design criteria.

SSED has been producing piezoresistive transducers since the mid-1960's. The Avionics Division produces a barometric pressure sensor that is used on the Douglas DC-10 as a pressure input to the on-board computer for measuring aircraft altitude in the Digital Air Data System. Pressure sensors have been produced for Honeywell's Process Control Division since 1972, and have been applied over input pressures from less than 1 psig to nearly 10,000 psig.

In 1972, MICRO SWITCH began to investigate piezoresistive device characteristics as a basis for further technology development. From 1972 to 1976, most of the MICRO SWITCH effort was concentrated on working with automobile manufacturers because of the unique and time sensitive opportunities that existed. This experience gave us an excellent base for moving into other markets. Since 1977, MICRO SWITCH has actively pursued the General Sales Markets.

In 1988/89 the fabrication of the piezoresistive sensors for MICRO SWITCH was transferred to its own facility located in Richardson, Texas. This facility now fabricates not only the pressure and force sensors but also a full line of other silicon based sensors including Hall effect, temperature, airflow, optoelectronic and others. This move provided MICRO SWITCH with a complete fabrication process from pure silicon to finished product.

Description

Piezoresistance of a semiconductor can be described as the change in resistance caused by an applied strain of the diaphragm. Thus, solid state resistors can be used as pressure and force sensors, much like wire strain gages, but with several important differences and advantages.

The high sensitivity, or gage factor, is perhaps 100 times that of wire strain gages. Piezoresistors are implanted into a homogeneous single crystalline silicon medium. The implanted resistors are thus integrated into the silicon force sensing member. Typically, other types of strain gages are bonded to force sensing members of dissimilar material, resulting in thermoelastic strain and complex fabrication processes. Most strain gages are inherently unstable due to degradation of the bond, as well as temperature sensitivity and hysteresis caused by the thermoelastic strain.

Silicon is an ideal material for receiving the applied force. Silicon is a perfect crystal and does not become permanently stretched. After being strained, it returns to the original shape. Silicon wafers are better than metal for pressure sensing diaphragms, as silicon has extremely good elasticity within its operating range. Silicon diaphragms normally fail only by rupturing.

PRESSURE SENSING

The sensing element of a MICRO SWITCH solid state pressure or force sensor consists of four nearly identical piezoresistors buried in the surface of a thin circular silicon diaphragm. The thin diaphragm is formed by chemically etching a square cavity into the surface opposite the piezoresistors. The unetched portion of the silicon slice provides a rigid boundary constraint for the diaphragm and a surface mounting to some other member.

A pressure or force causes the thin diaphragm to flex, inducing a stress or strain in the diaphragm and also in the buried resistors. The resistor values will change depending on the amount of strain they undergo, which depends on the amount of pressure or force applied to the diaphragm. Therefore, a change in pressure (mechanical input) is converted to a change in resistance (electrical output). The sensing element converts (transduces) energy from one form to another.

The resistors can be connected in either a half-bridge or a full Wheatstone bridge arrangement. For a pressure or force applied to the diaphragm using a full bridge arrangement, the resistors can be theoretically approximated as shown in Figure 1 (non-amplified units).

$R \pm \Delta R$ and $R - \Delta R$ represent the actual resistor values at the applied pressure or force. R represents the resistor value for the undeflected diaphragm ($P = 0$) where all four resistors are nearly equal in value. ΔR represents the change in resistance due to an applied pressure or force. All four resistors will change by approximately the same value. Note that two resistors increase and two decrease depending on their orientation with respect to the crystalline direction of the silicon material.

The signal voltage generated by the full bridge arrangement is proportional to the amount of supply voltage (V_{CC}) and the amount of pressure or force applied which generates the resistance change ΔR .

Figure 1

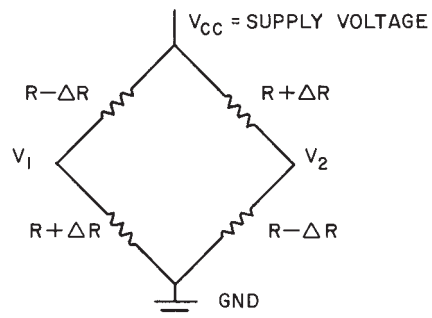

Pressure Sensors

Measurement Types

MEASUREMENT TYPES

Absolute pressure is measured with respect to a vacuum reference, an example of which is the measurement of barometer pressure. In absolute devices the P2 port is sealed with a vacuum representing a fixed reference. The difference in pressure between the vacuum reference and the measurand applied at the P1 port causes the deflection of the diaphragm, producing the output voltage change.

Absolute Pressure

Signal conditioned sensor output is shown. One volt output represents perfect vacuum.

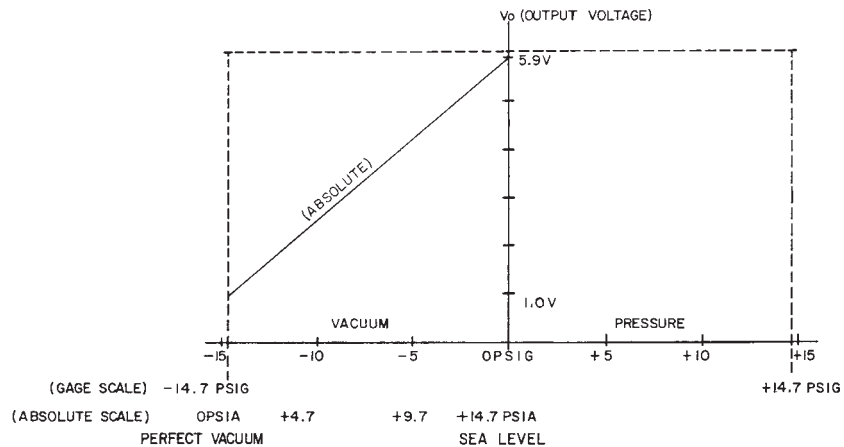
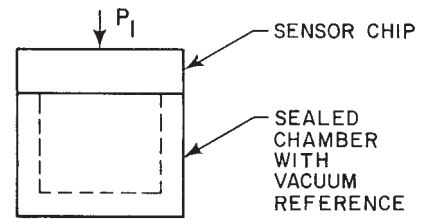

Differential pressure is the difference between two pressures. For instance, the measurement of pressure dropped across an orifice or venturi used to compute flow rate. In differential devices measurands are applied to both ports.

Differential Pressure

Signal conditioned sensor output is shown. One volt output occurs when pressures are equal on both ports.

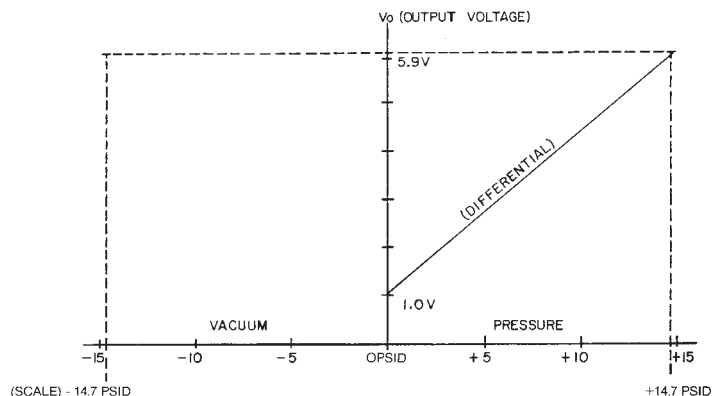
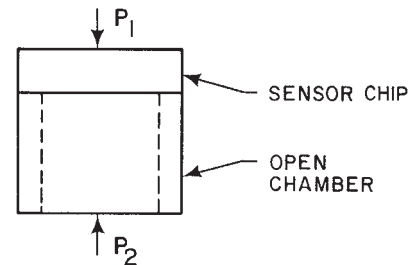

Pressure and Force Sensors

Measurement Types

MEASUREMENT TYPES

Gage pressure is a form of differential pressure measurement in which atmospheric pressure is used as the reference. Measurement of auto tire pressure, where a pressure above atmosphere is needed to maintain tire performance characteristics, is an example. In gage devices the P1 port is vented to atmospheric pressure and the measurand is applied to the P2 port.

Gage Pressure

High level output is shown. One volt output represents ambient pressure.

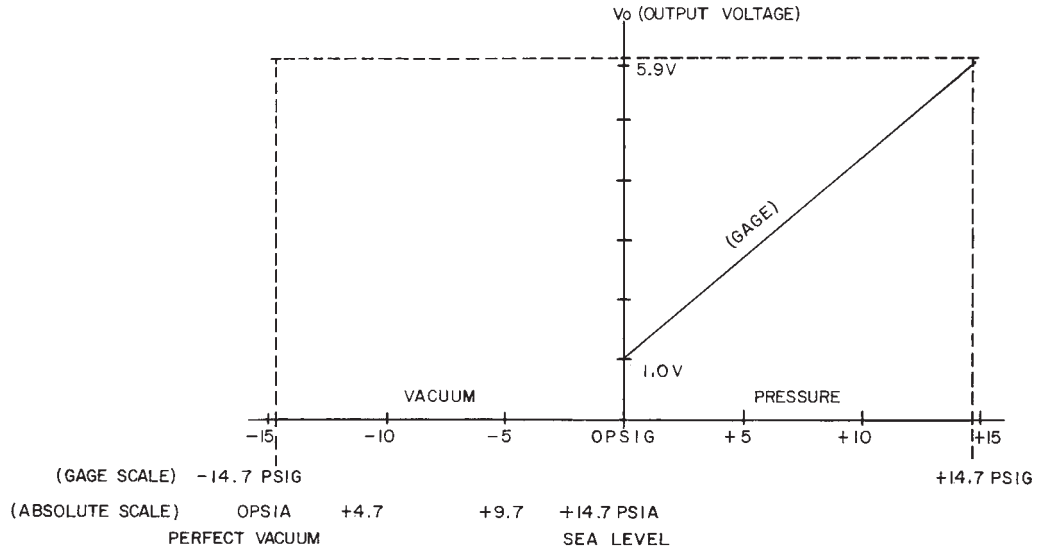
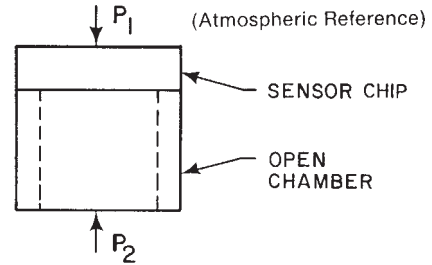

Vacuum Gage pressure is a form of pressure measurement in which vacuum pressures are sensed with reference to ambient pressure.

Vacuum Gage Pressure

High level sensor output is shown. One volt output represents ambient pressure.

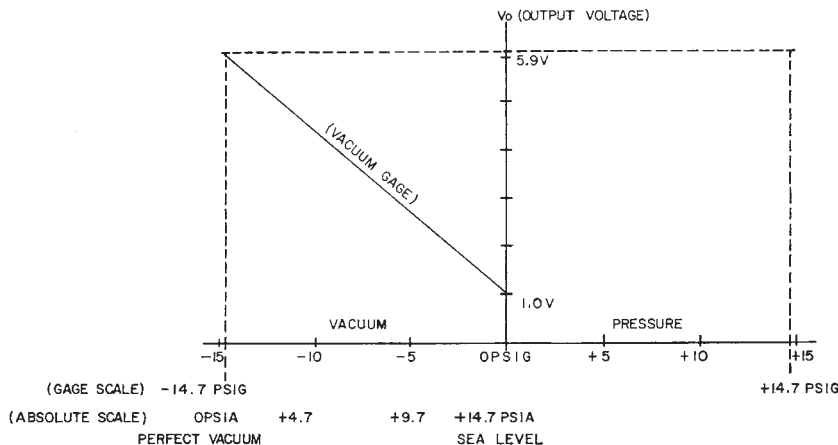
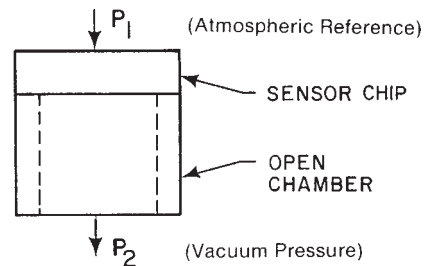

Reference/Index