

Installation Instructions for the RPNS090AA2A11X Hall-Effect Rotary Position Sensor

ISSUE 1
50035278

GENERAL INFORMATION

The RPN Series Rotary Position Sensors use a magnetically biased, Hall-effect integrated circuit (IC) to accurately sense rotary movement of the actuator shaft. Rotation of the actuator shaft changes the IC's position relative to the magnets. The resulting flux density change is converted to a linear output.

MOUNTING INFORMATION

Mount the sensor using the two easily accessible mounting holes. Mounting screw tightening torque is 2,5 N m \pm 0,5 N m [22.1 in lb \pm 4.4 in lb].

Table 1. Output

Angle	Output
Left (-45°)	4.75 Vdc
0°	2.5 Vdc
Right (+45°)	0.25 Vdc

Figure 1. Mounting and Dimensional Diagram (For Reference Only mm/[in].)

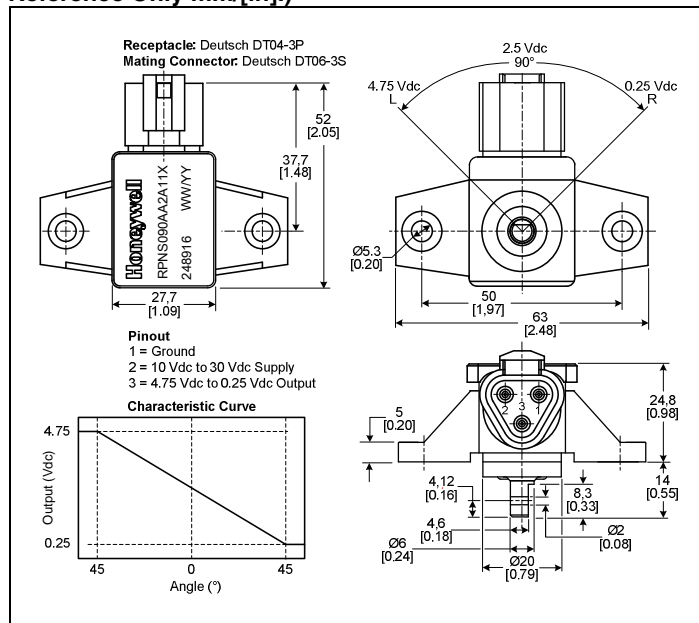

Table 2. Specifications

Characteristic	Parameter
Supply voltage	10 Vdc to 30 Vdc
Current consumption (maximum)	20 mA
Output signal delay (approx)	3 ms
Reverse polarity protection	yes
EMC	200 V/m ISO 11452-3
Operating and storage temperature range	-40 °C to 125 °C [-40 °F to 257 °F]
Protection class	IP67 DIN 40050
Accuracy	\pm 1.6%
Hysteresis	none
Linearity	\pm 2°
Housing material	PA66 plastic
Shaft material	stainless steel
Expected life	30x10 ⁶ cycles
Mechanical end stop	no

⚠ WARNING

PERSONAL INJURY

DO NOT USE these products as safety or emergency stop devices or in any other application where failure of the product could result in personal injury.

Failure to comply with these instructions could result in death or serious injury.

WARRANTY/REMEDY

Honeywell warrants goods of its manufacture as being free of defective materials and faulty workmanship. Honeywell's standard product warranty applies unless agreed to otherwise by Honeywell in writing; please refer to your order acknowledgement or consult your local sales office for specific warranty details. If warranted goods are returned to Honeywell during the period of coverage, Honeywell will repair or replace, at its option, without charge those items it finds defective. **The foregoing is buyer's sole remedy and is in lieu of all other warranties, expressed or implied, including those of merchantability and fitness for a particular purpose. In no event shall Honeywell be liable for consequential, special, or indirect damages.**

While we provide application assistance personally, through our literature and the Honeywell web site, it is up to the customer to determine the suitability of the product in the application.

Specifications may change without notice. The information we supply is believed to be accurate and reliable as of this printing. However, we assume no responsibility for its use.

SALES AND SERVICE

Honeywell serves its customers through a worldwide network of sales offices, representatives and distributors. For application assistance, current specifications, pricing or name of the nearest Authorized Distributor, contact your local sales office or:

E-mail: info.sc@honeywell.com

Internet: www.honeywell.com/sensing

Phone and Fax:

Asia Pacific	+65 6355-2828
	+65 6445-3033 Fax
Europe	+44 (0) 1698 481481
	+44 (0) 1698 481676 Fax
Latin America	+1-305-805-8188
	+1-305-883-8257 Fax
USA/Canada	+1-800-537-6945
	+1-815-235-6847
	+1-815-235-6545 Fax