

MODEL FP2000

008835

Issue 5

Differential Pressure Transducer

DESCRIPTION

The FP2000 series is a configurable differential pressure transducer which allows the customer to select the configuration which best fits the needs of the application. Choose from multiple accuracies, outputs, pressure ports, electrical terminations, and pressure ranges.

The FP2000 is available with differential wet/wet and wet/dry configurations.

DIFFERENTIATION

- Welded stainless steel construction
- Customized specifications available
- Configurable platform enables a sensor to be built to customer requirements
- Bi-directional functionality of pressure measurement
- Optional bi-directional calibration available
- Small package size

VALUE TO CUSTOMERS

- Built on the Honeywell history of higher-quality pressure sensing technologies
- Configurable platform creates a wide range of standard configurations
- Broad compensated temperature ranges
- Multiple outputs to choose from to meet variety of application needs

POTENTIAL APPLICATIONS

- Test stands (automotive, aerospace, and industrial)
- R&D test labs
- Hydraulic and pneumatic system monitoring
- Leak detection
- Pump and compressor control
- Tank level measurement
- Monitor pressure changes for preventive maintenance
- Flow rate measurement



FEATURES

- mV/V, 4 mA to 20 mA, ± 5 Vdc, ± 10 Vdc
- Differential (wet/wet, wet/dry)
- Multiple electrical connector and pressure port offerings
- Intrinsically safe option
- CE available

FP2000 pressure sensors are custom built from stocked components. Please see <http://sensing.honeywell.com> for updated listings

PORTFOLIO



From general process pressure transducers to hazardous location pressure products, Honeywell offers a comprehensive selection of gage, absolute, differential, vacuum, and barometric pressure transducers to meet market demands. Each of our transducers can be customized to meet your needs, whatever your application. To view the entire product portfolio, [click here](#).

Honeywell

DIFFERENTIAL PRESSURE TRANSDUCER, MODEL FP2000

TABLE 1. PERFORMANCE SPECIFICATIONS

CHARACTERISTIC	MEASURE
Accuracy	see Note 1
Output (selectable)	mV/V, 4 mA to 20 mA (two wire), ±5 Vdc, ±10 Vdc
Resolution	Infinite

TABLE 2. ELECTRICAL SPECIFICATIONS

CHARACTERISTIC	MEASURE
Amplified (4 mA to 20 mA; ±5 Vdc)	9 Vdc to 28 Vdc
Amplified (±10 Vdc)	15 Vdc to 28 Vdc
Unamplified (mV/V)	10 Vdc

TABLE 3. MECHANICAL SPECIFICATIONS

CHARACTERISTIC	MEASURE
Media	Gas, liquid
Overload safe Positive (+) direction Model FDW and FDD	4X full scale or 3000 psi whichever is less
Overload safe Negative (-) direction Model FDW and FDD	4X full scale or 250 psi whichever is less
Overload burst Positive (+) direction Model FDW and FDD	3000 psi
Overload burst Negative (-) direction Model FDW and FDD	500 psi
Wetted material	Ha C276 & 316L Stainless Steel

FIGURE 1. TYPICAL SYSTEM DIAGRAM

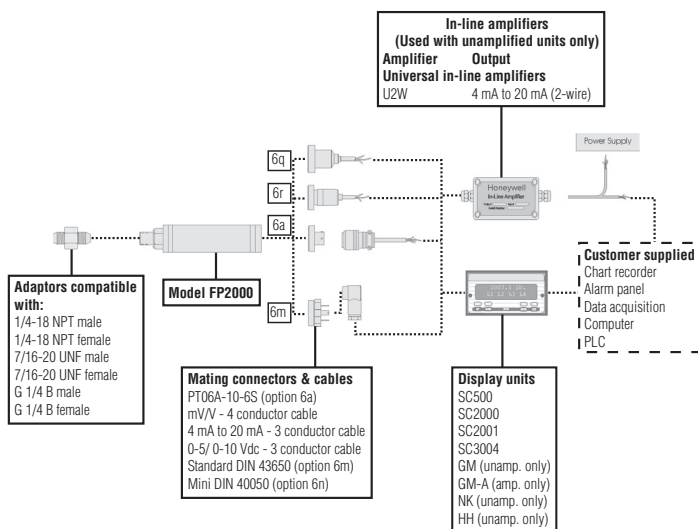

Note 1: Unless otherwise specified on order, amplified units with 4 mA to 20 mA output will provide 4 mA at 0 psid and 20 mA at positive full scale and the unit will not operate in the negative direction. Consult Factory to specify 4 mA at negative full scale and 20 mA at positive full scale.

Note 2: All amps add 2 inches to sensor housing length.

TABLE 4. ENVIRONMENTAL SPECIFICATIONS

ORDER CODE	RANGE	TEMPERATURE, COMPENSATED	TEMPERATURE, OPERATING <i>Unamplified Output: Option 2U</i>	TEMPERATURE, OPERATING <i>Voltage Output: Option 2D,2E,2F,2G Current Output: Option 2P,2Y,2N</i>
FDD	less than 1 psi	10 °C to 45 °C [50 °F to 110 °F]	-40 °C to 116 °C [-40 °F to 240 °F]	-29 °C to 85 °C [-20 °F to 185 °F]
	1 psi and less than 5 psi	5 °C to 50 °C [40 °F to 120 °F]		
	5 psi and above	5 °C to 60 °C [40 °F to 140 °F]		
FDW	less than 1 psi	10 °C to 45 °C [50 °F to 110 °F]	-40 °C to 116 °C [-40 °F to 240 °F]	-29 °C to 85 °C [-20 °F to 185 °F]
	1 psi and less than 5 psi	5 °C to 50 °C [40 °F to 120 °F]		
	5 psi and above	5 °C to 60 °C [40 °F to 140 °F]		
Temperature, error band	0.10 % accuracy	±0.5 % full scale	-	-
	0.25 % accuracy	±1.0 % full scale	-	-

DIFFERENTIAL PRESSURE TRANSDUCER, MODEL FP2000

TABLE 5. INTERNAL AMPLIFIERS

AMPLIFIER SPECIFICATIONS	UNAMPLIFIED OUTPUT: OPTION 2U	VOLTAGE OUTPUT: OPTION 2D	VOLTAGE OUTPUT: OPTION 2G	CURRENT TWO-WIRE: OPTION 2P
Output signal at null	0 Vdc	0 Vdc	0 Vdc	4 mA
Output signal at full scale output	50 mV	5 Vdc	10 Vdc	20 mA
Input power (voltage)	10 Vdc	9 Vdc to 28 Vdc	15 Vdc to 28 Vdc	9 Vdc to 32 Vdc
Input power (current)	2 mA @ 10 Vdc	10 mA	15 mA	4 mA to 24 mA
Frequency response	Natural frequency	300 Hz	300 Hz	300 Hz
Power supply rejection	N/A	60 dB	60 dB	60 dB
Operating temperature	-40 °C to 116 °C [-40 °F to 240 °F]	-29 °C to 85 °C [-20 °F to 185 °F]	-29 °C to 85 °C [-20 °F to 185 °F]	-29 °C to 85 °C [-20 °F to 185 °F]
Reverse voltage protection	N/A	Yes	Yes	Yes
Short circuit protection	N/A	Momentary	Momentary	Yes

AMPLIFIER SPECIFICATIONS	VOLTAGE OUTPUT: OPTION 2E	VOLTAGE OUTPUT: OPTION 2F	INTRINSICALLY SAFE AMP: OPTION 2N (2N)***	CURRENT TWO-WIRE: OPTION 2Y
Output signal at null	0 Vdc	0 Vdc	4 mA	4 mA
Output signal at full scale output	5 Vdc	10 Vdc	20 mA	20 mA
Input power (voltage)	9 Vdc to 28 Vdc	15 Vdc to 28 Vdc	9 Vdc to 28 Vdc	9 Vdc to 32 Vdc
Input power (current)	10 mA	15 mA	4 mA to 24 mA	4 mA to 24 mA
Frequency response	2000 Hz	2000 Hz	2000 Hz	2000 Hz
Power supply rejection	60 dB	60 dB	60 dB	60 dB
Operating temperature	-29 °C to 85 °C [-20 °F to 185 °F]	-29 °C to 85 °C [-20 °F to 185 °F]	-29 °C to 85 °C [-20 °F to 185 °F]	-29 °C to 85 °C [-20 °F to 185 °F]
Reverse voltage protection	Yes	Yes	Yes	Yes
Short circuit protection	Momentary	Momentary	Yes	Yes

DIFFERENTIAL PRESSURE TRANSDUCER, MODEL FP2000

FIGURE 2. MOUNTING DIMENSIONS

ELECTRICAL TERMINATION

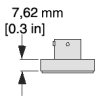
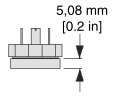
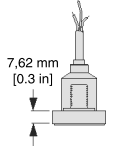
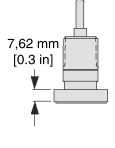
Code 6a: 6-pin, vented, Bendix style	Code 6m: 4-pin, vented, standard DIN (43650)	Code 6q: 4-conductor, vented, integral cable, 1,52 m [5 ft]	Code 6r: 4-conductor, vented, integral cable, conduit fitting 1,52 m [5 ft]
			

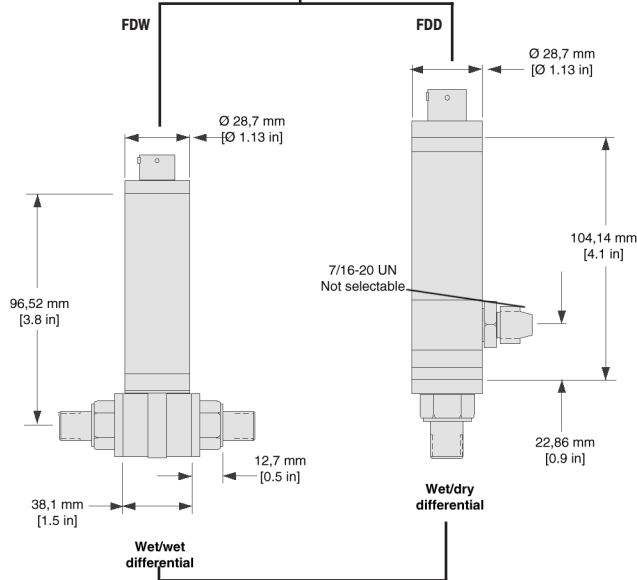

PRESSURE PORTS

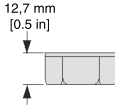
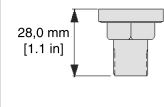
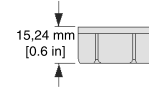
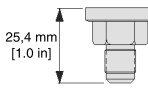
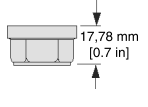
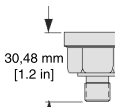
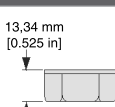
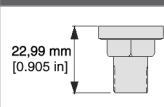
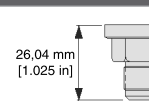
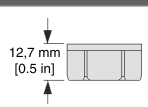
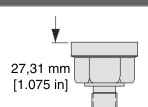
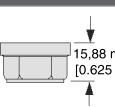
	Code 5a 1/4-18 NPT female	Code 5b 1/4-18 NPT male	Code 5c 7/16-20 UNF female	Code 5d 7/16-20 UNF male	Code 5f G 1/4 B female	Code 5g G 1/4 B male
Up to 1000 psi						
Up to 1000 psi						

DIFFERENTIAL PRESSURE TRANSDUCER, MODEL FP2000

TABLE 7. WIRING CODES

	UNAMPLIFIED OUT-PUT: OPTION 2U		VOLTAGE OUTPUT: OPTION 2D/2E		VOLTAGE OUTPUT: OPTION 2G/2F		CURRENT TWO-WIRE: OPTION 2P/2Y		INTRINSICALLY SAFE AMP: OPTION 2N (2N)***	
BENDIX PTIH-10-6P (OPTION 6A)										
No shunt cal	A	(+) Excitation	A	(+) Supply	A	(+) Supply	A	(+) Supply	A	(+) Supply
	B	(+) Excitation	B	(-) Supply return	B	(-) Supply return	B	No connection	B	No connection
	C	(-) Excitation	C	(-) Output 0 Vdc to 5 Vdc	C	(-) Output 0 Vdc to 10 Vdc	C	No connection	C	No connection
	D	(-) Excitation					D	(+) Output 4 mA to 20 mA	D	(+) Output 4 mA to 20 mA
	E	(-) Output	D	(+) Output	D	(+) Output Vdc	E	No connection	E	Case ground
	F	(+) Output	E	No connection	E	No connection	F	No connection	F	No connection
			F	No connection	F	No connection				
With shunt cal (option 3d)	A	(+) Excitation	A	(+) Supply	A	(+) Supply	A	(+) Supply	A	(+) Supply
	B	(-) Excitation	B	(-) Supply return	B	(-) Supply return	B	No connection	B	No connection
	C	(+) Output	C	(-) Output 0 Vdc to 5 Vdc	C	(-) Output 0 Vdc to 10 Vdc	C	No connection	C	No connection
	D	(-) Output					D	(+) Output 4 mA to 20 mA	D	(+) Output 4 mA to 20 mA
	E	No connection	D	(+) Output	D	(+) Output	E	No connection	E	No connection
	F	Shunt Cal	E	No connection	E	No connection	F	Shunt cal	F	Shunt cal
			F	Shunt cal	F	Shunt cal				
STD. DIN 43650 (OPTION 6M)										
No shunt cal	1	(+) Excitation	1	(+) Supply	1	(+) Supply	1	(+) Supply	1	(+) Supply
	2	(+) Output	2	(+) Output	2	(+) Output	2	(+) Output 4 mA to 20 mA	2	(+) Output
	3	(-) Output	3	Supply/ output com.	3	Supply/ output com.	3	No connection	3	Case ground
	4	(-) Excitation	GND	No connect. to case	GND	No connect. to case	GND	No connection	GND	No connection
With shunt cal (option 3d)	Not Applicable		1	(+) Supply	1	(+) Supply	1	(+) Supply	1	(+) Supply
			2	(+) Output	2	(+) Output	2	(+) Output 4 mA to 20 mA	2	(+) Output
			3	Supply/output com.	3	Supply/output com.	3	No connection	3	Case ground
			GND	Shunt cal	GND	Shunt cal	GND	Shunt cal	GND	Shunt cal
1.83 M [5 FT] INTEGRAL CABLE (OPTION 6Q)										
No shunt cal	R	(+) Excitation	R	(+) Supply	R	(+) Supply	R	(+) Supply	R	(+) Supply
	Bl	(-) Excitation	Bl	(-) Supply return	Bl	(-) Supply return	Bl	(+) Output 4 mA to 20 mA	Bl	(+) Output 4 mA to 20 mA
	G	(-) Output	G	(-) Output	G	(-) Output				
	W	(+) Output	W	(+) Output 0 Vdc to 5 Vdc	W	(+) Output 0 Vdc to 10 Vdc			W	Case ground
With shunt cal (option 3d)	Not Applicable		R	(+) Supply	R	(+) Supply	R	(+) Supply	R	(+) Supply
			Bl	(-) Supply return	Bl	(-) Supply return	Bl	(+) Output 4 mA to 20 mA	Bl	(+) Output 4 mA to 20 mA
			G	Shunt cal	G	Shunt cal	G	Shunt cal	G	Shunt cal
			W	(+) Output 0 Vdc to 5 Vdc	W	(+) Output 0 Vdc to 10 Vdc			W	Case ground
CONDUIT FITTING (OPTION 6R)										
No shunt cal	R	(+) Excitation	R	(+) Supply	R	(+) Supply	R	(+) Supply	R	(+) Supply
	Bl	(-) Excitation	Bl	(-) Supply return	Bl	(-) Supply return	Bl	(+) Output 4 mA to 20 mA	Bl	(+) Output 4 mA to 20 mA
	G	(-) Output	G	(-) Output	G	(-) Output				
	W	(+) Output	W	(+) Output 0 Vdc to 5 Vdc	W	(+) Output 0 Vdc to 10 Vdc			W	Case ground
With shunt cal (option 3d)	Not Applicable		R	(+) Supply	R	(+) Supply	R	(+) Supply	R	(+) Supply
			Bl	(-) Supply return	Bl	(-) Supply return	Bl	(+) Output 4 mA to 20 mA	Bl	(+) Output 4 mA to 20 mA
			G	Shunt cal	G	Shunt cal	G	Shunt cal	G	Shunt cal
			W	(+) Output 0 Vdc to 5 Vdc	W	(+) Output 0 Vdc to 10 Vdc			W	Case ground

Note: For wiring codes, R=red; Bl = black; W = white; G = green. Color specifies cable and letter or number specifies connection

*** See Honeywell's Web site (<http://measurementsensors.honeywell.com>) for most up-to-date information regarding Intrinsically Safe approvals ref. #008-0547-00.

DIFFERENTIAL PRESSURE TRANSDUCER, MODEL FP2000

HOW TO ORDER

The **FP2000 Order Code** is an easy way for you to order exactly what you want the factory to build. Simply make one selection in each of the six required categories. Choose adders and accessories only if you require them. By visiting our Web site at www.honeywell.com/sensing you can view complete technical specifications for the FP2000, or click to our on-line shopping site and actually place your order.

Step 1

TRANSDUCER TYPE

- Differential - wet/wet
- Differential - wet/dry

Type Code
FDW
FDD

Unit type

- psi
- torr
- mBar
- kPa
- bar
- in Hg
- mm Hg
- in H₂O

Step 4

ADDERS

- | | |
|--|------------------|
| <input type="checkbox"/> Enhanced thermals
Differential: 0 °F to 180 °F | Adder code
1y |
| <input type="checkbox"/> Shunt cal | 3d |
| <input type="checkbox"/> CE rating | 9e |
| <input type="checkbox"/> Zero and span adjustments | 14c |
| <input type="checkbox"/> mV/V | 2u |
| <input type="checkbox"/> 5 Vdc | 2e |
| <input type="checkbox"/> 10 Vdc | 2f |
| <input type="checkbox"/> 4 mA to 20 mA (CE only) | 2y |
| <input type="checkbox"/> 4 mA to 20 mA (IS and CE) | 2n (2N) |

NOTE: If you choose any adder output from step 4, you must revise your output code selection using this output code chart. IS outputs available only on ranges up to 5000 psi.

ACCESSORIES

Mating connectors only

- | | |
|-----------------------------------|--------------------|
| <input type="checkbox"/> Mini DIN | Acc. code
AA161 |
| <input type="checkbox"/> Bendix | AA111 |

Mating conn. with 15 ft. cable for Bendix connector (6A)

- | | | |
|---|---------------|-----------------|
| | Without shunt | With shunt (3d) |
| <input type="checkbox"/> mV/V | AA113 | AA513 |
| <input type="checkbox"/> 4 mA to 20 mA | AA116 | AA516 |
| <input type="checkbox"/> 0 to 5/0 to 10 Vdc | AA117 | AA517 |

Step 2

PRESSURE RANGE

Differential

- | | | | |
|----------------------------------|----|-----------------------------------|----|
| <input type="checkbox"/> 0.5 psi | AN | <input type="checkbox"/> 100 psi | BR |
| <input type="checkbox"/> 1 psi | AP | <input type="checkbox"/> 150 psi | CJ |
| <input type="checkbox"/> 2 psi | AR | <input type="checkbox"/> 200 psi | CL |
| <input type="checkbox"/> 2.5 psi | AS | <input type="checkbox"/> 250 psi | CN |
| <input type="checkbox"/> 5 psi | AT | <input type="checkbox"/> 300 psi | CP |
| <input type="checkbox"/> 10 psi | AV | <input type="checkbox"/> 400 psi | CQ |
| <input type="checkbox"/> 15 psi | BJ | <input type="checkbox"/> 500 psi | CR |
| <input type="checkbox"/> 25 psi | BL | <input type="checkbox"/> 600 psi | CS |
| <input type="checkbox"/> 30 psi | BM | <input type="checkbox"/> 750 psi | CT |
| <input type="checkbox"/> 50 psi | BN | <input type="checkbox"/> 1000 psi | CV |
| <input type="checkbox"/> 75 psi | BP | | |

ACCURACY

- | | |
|---------------------------------|--------------------|
| <input type="checkbox"/> 0.10 % | Accuracy code
1 |
| <input type="checkbox"/> 0.25 % | 2 |

Step 3

OUTPUT

- | | | |
|---|-------------------------|---|
| <input type="checkbox"/> mV/V | Basic output code
2u | If adding
1y, 3d, 9e
or 14c
2u |
| <input type="checkbox"/> 5 Vdc | 2d | 2e |
| <input type="checkbox"/> 10 Vdc | 2g | 2f |
| <input type="checkbox"/> 4 mA to 20 mA | 2p | 2y |
| <input type="checkbox"/> 4 mA to 20 mA (IS) | 2N | 2y |

NOTE: If any ADDERS are required, the output code must be revised. See step 4.

PRESSURE PORT

- | | |
|---|-----------------|
| <input type="checkbox"/> 1/4-18 NPT female | Port code
5a |
| <input type="checkbox"/> 1/4-18 NPT male | 5b |
| <input type="checkbox"/> 7/16-20 UNF female | 5c |
| <input type="checkbox"/> 7/16-20 UNF male | 5d |
| <input type="checkbox"/> G 1/4 B female | 5f |
| <input type="checkbox"/> G 1/4 B male | 5g |
| <input type="checkbox"/> 1/8-27 NPT female | 5h |
| <input type="checkbox"/> 1/8-27 NPT male | 5i |
| <input type="checkbox"/> M12 x 1.5 male | 5p |
| <input type="checkbox"/> M12 x 1.5 female | 5q |
| <input type="checkbox"/> 9/16-18 UNF SAE male | 5r |
| <input type="checkbox"/> 9/16-18 UNF SAE female | 5s |

ELECTRICAL CONNECTOR

- | | |
|---|----------------------|
| <input type="checkbox"/> Bendix PTIH-10-6P | Connector code
6a |
| <input type="checkbox"/> DIN 43650 | 6m |
| <input type="checkbox"/> Mini DIN (40050) | 6n |
| <input type="checkbox"/> Integral polyurethane 5-ft cable | 6q |
| <input type="checkbox"/> 1/2 x 14 NPT conduit 5-ft cable exit | 6r |

Step 5

EXAMPLE ORDER CODE

FDW 1 CN 1Y 2Y 5B 6A

Selection

Transducer type
Accuracy
Pressure range
Adders
Output
Pressure port
Electrical output connections

Description

Differential wet/wet
0.10 %
250 psi
Enhanced temperature range
4 mA to 20 mA
1/4-18 NPT male
Bendix PTIH-10-6P

Code

FDW
1
CN
1y
2y
5b
6a

There must be a code in each of the six basic code boxes. If there are no adders or accessories chosen, leave the boxes blank.

DESCRIPTION	BASIC CODE					ADDER CODE (SEE STEP 4)				
	Type	Accuracy	Range	Output	Pressure	Elect. conn.	Extended	Shunt cal.	IS/CE rated	Pots
Order code										
Accessory code										

Zero and span adjustments are located on the side. See drawing for details. No zero and span adjustments are available on mV/V output option.

NOTES

1. Accuracies stated are expected for best-fit straight line for all errors, including linearity, hysteresis, and non-repeatability through zero.
2. For low pressure ranges, temperature effects may vary.
3. The wet/wet differential pressure transducer has two separate, welded Hastelloy diaphragms. In wet/dry unit, the wet port (high port) has all-welded stainless steel and Hastelloy construction. The dry port (low port) has no isolation diaphragm.
4. For differential pressure ranges at 0.10 % accuracy, non-amplified output @ 10 Vdc excitation = 100 mV.

WARRANTY/REMEDY

Honeywell warrants goods of its manufacture as being free of defective materials and faulty workmanship during the applicable warranty period. Honeywell's standard product warranty applies unless agreed to otherwise by Honeywell in writing; please refer to your order acknowledgment or consult your local sales office for specific warranty details. If warranted goods are returned to Honeywell during the period of coverage, Honeywell will repair or replace, at its option, without charge those items that Honeywell, in its sole discretion, finds defective.

The foregoing is buyer's sole remedy and is in lieu of all other warranties, expressed or implied, including those of merchantability and fitness for a particular purpose. In no event shall Honeywell be liable for consequential, special, or indirect damages.

While Honeywell may provide application assistance personally, through our literature and the Honeywell web site, it is buyer's sole responsibility to determine the suitability of the product in the application.

Specifications may change without notice. The information we supply is believed to be accurate and reliable as of this writing. However, Honeywell assumes no responsibility for its use.

FOR MORE INFORMATION

Honeywell Sensing and Internet of Things services its customers through a worldwide network of sales offices and distributors. For application assistance, current specifications, pricing or the nearest Authorized Distributor, visit sensing.honeywell.com or call:

Asia Pacific	+65 6355-2828
Europe	+44 1698 481481
USA/Canada	+1-800-537-6945

Honeywell Sensing and Internet of Things

9680 Old Bailes Road
Fort Mill, SC 29707
honeywell.com

008835-5-EN | 5 | 08/19
© 2019 Honeywell International Inc. All rights reserved.

WARNING PERSONAL INJURY

DO NOT USE these products as safety or emergency stop devices or in any other application where failure of the product could result in personal injury.

Failure to comply with these instructions could result in death or serious injury.

WARNING MISUSE OF DOCUMENTATION

- The information presented in this product sheet is for reference only. Do not use this document as a product installation guide.
- Complete installation, operation, and maintenance information is provided in the instructions supplied with each product.

Failure to comply with these instructions could result in death or serious injury.

Honeywell